



# Ranger<sup>®</sup> 7000 Scales Instruction Manual





## TABLE OF CONTENTS

1. INTRODUCTION.....	4
1.1 Description .....	4
1.2 Features .....	4
1.3 Definition of Signal Warnings and Symbols .....	4
1.4 Safety Precautions .....	4
2. INSTALLATION .....	5
2.1 Unpacking .....	5
2.2 Installing Components.....	6
2.2.1 Terminal Setup .....	6
2.2.2 Installing the Wind Ring, Weighing Platform .....	6
2.3 Selecting the Location.....	6
2.4 Connecting Power and Turning ON the Scale .....	6
2.5 Connecting the Interface .....	7
2.6 Leveling the scale .....	7
2.7 Remote Terminal Operation.....	7
2.8 Separating the Terminal from the Weighing Base .....	8
2.9 Terminal Mounting .....	8
2.10 Initial Calibration.....	8
2.10.1 Internal calibration.....	8
2.10.2 External calibration.....	8
3. OPERATION .....	9
3.1 Overview of Display, Home Screen .....	9
3.2 Principal Functions and Main Menu .....	10
3.3 Overview of Parts and Features.....	11
4. APPLICATIONS .....	12
4.1 Weighing .....	12
4.1.1 Application Setup .....	13
4.1.2 Accumulation .....	13
4.1.3 Weighing ID .....	14
4.1.4 Input/Output (I/O) Setup .....	14
4.2 Counting.....	15
4.2.1 Set the Average Piece Weight (APW).....	16
4.2.2 Application Setup .....	17
4.2.3 Smart Sampling .....	18
4.2.4 Accumulation .....	19
4.2.5 Input/Output (I/O) Setup .....	19
4.2.6 STR Scanning Process .....	19
4.3 Check .....	20
4.3.1 Check Weighing (default).....	20
4.3.2 Check Counting.....	21
4.3.3 Application Setup .....	22
4.3.4 Input/Output (I/O) Setup .....	23
4.4 Formulation .....	25
4.4.1 Free Formulation (default).....	25
4.4.2 Recipe Formulation .....	26
4.4.3 Factor and Tolerance Setup.....	27
4.4.4 Application Setup .....	28
4.4.5 Input/Output (I/O) Setup .....	28
4.5 Percent Weighing.....	29
4.5.1 Establishing a Reference Weight .....	30
4.5.2 Application Setup .....	30
4.6 Filling.....	31
4.6.1 Weight Filling.....	31
4.6.2 Parts Filling.....	32
4.6.3 Application Setup .....	35
4.6.4 Input/Output (I/O) Setup .....	36
4.7 Dynamic Weighing .....	37
4.7.1 Application Setup .....	38
4.7.2 Average Time Setup.....	38
4.7.3 Input/Output (I/O) Setup .....	39
4.8 Density Determination.....	40
4.8.1 Application Setup .....	40

4.8.2	Water Temperature / Liquid Density Setup .....	41
4.9	Differential Weighing .....	42
4.9.1	Application Setup .....	42
4.9.2	Differential Operation .....	43
4.10	Sieve Weighing .....	43
4.10.1	Application Setup .....	44
4.10.2	Sieve Operation .....	44
4.11	Library .....	47
4.11.1	Creating a Library Record .....	47
4.11.2	Retrieving a Library Record .....	48
4.11.3	Editing a Stored Library Record .....	48
4.11.4	Deleting a Stored Library Record .....	49
4.12	Additional Features .....	49
4.12.1	Weigh Below .....	49
5.	MENU SETTINGS .....	50
5.1	Menu Navigation .....	50
5.2	Main Menu .....	51
5.3	Calibration .....	51
5.3.1	Calibration sub-menu .....	51
5.3.2	Zero Calibration .....	52
5.3.3	Span Calibration .....	52
5.3.4	Linearity Calibration .....	52
5.3.5	Internal Calibration (R71MHD models) .....	52
5.3.6	Automatic Calibration (R71MHD models) .....	52
5.3.7	AutoCal™ Adj (Adjustment) .....	52
5.3.8	GEO Adjustment .....	53
5.4	Setup .....	53
5.4.1	Scale Setup sub-menu .....	53
5.4.2	Reset .....	53
5.4.3	Language .....	53
5.4.4	Power On Unit .....	54
5.4.5	Power On Zero .....	54
5.4.6	Key Beep .....	54
5.4.7	Expand Display .....	54
5.4.8	Barcode Rule .....	54
5.4.9	Barcode Confirm .....	55
5.4.10	I/O Type .....	55
5.5	Read Out .....	56
5.5.1	Reset .....	56
5.5.2	Stability .....	56
5.5.3	Zero Range .....	56
5.5.4	Filter level .....	56
5.5.5	Auto Zero Tracking .....	56
5.5.6	Brightness .....	57
5.5.7	Auto Dim (minutes) .....	57
5.5.8	Auto Sleep (minutes) .....	57
5.5.9	Window On Top .....	57
5.6	Application Mode .....	57
5.6.1	Turning an Application ON/OFF .....	57
5.7	Weighing Units .....	57
5.7.1	Units Sub-menu .....	58
5.7.2	Reset .....	58
5.7.3	Turning a Unit ON/OFF .....	58
5.8	GLP and GMP Data .....	58
5.8.1	Reset .....	59
5.8.2	Date Format .....	59
5.8.3	Date .....	59
5.8.4	Time Format .....	59
5.8.5	Time .....	59
5.8.6	Project ID .....	59
5.8.7	Scale ID .....	59
5.9	Communication .....	59
5.9.1	Reset .....	59
5.9.2	Baud Rate .....	60

5.9.3 Parity .....	60
5.9.4 Stop Bits .....	60
5.9.5 Handshake .....	60
5.9.6 Alternate Command .....	60
5.9.7 Reference Balance .....	60
5.9.8 Reset .....	60
5.9.9 Stable Weight Only .....	60
5.9.10 SICS .....	61
5.9.11 Print Options .....	61
5.9.12 Auto Print .....	61
5.9.13 Print Cal Data .....	62
5.9.14 Select Template .....	62
5.9.15 Edit Template .....	63
5.9.16 Edit String .....	64
5.9.17 Data Transfer .....	65
5.10 User .....	66
5.10.1 User Profiles .....	66
5.10.2 Supervisor Authority .....	68
5.10.3 Password Rule .....	68
5.11 Lock Key .....	69
5.12 Memory .....	70
5.12.1 Log Memory .....	70
5.12.2 USB memory .....	70
5.12.3 Alibi memory .....	71
5.13 Maintenance .....	74
5.13.1 Export Library .....	74
5.13.2 Export User Profile .....	74
5.13.3 Import Library Drives .....	74
5.13.4 Import User Profile .....	74
6. SERIAL COMMUNICATION .....	75
6.1 Interface Commands .....	75
6.2 RS232 Interface .....	77
6.2.1 Connecting to a Computer .....	77
6.2.2 Connecting to a Serial Printer .....	77
6.2.3 System Requirements .....	77
6.2.4 USB Connection .....	77
6.2.5 Virtual Port Software Installation .....	78
6.3 USB Host .....	78
6.4 Printout Format .....	78
6.5 Printout Examples .....	80
7. LEGAL FOR TRADE .....	81
7.1 Settings .....	81
7.2 Verification .....	81
7.3 Sealing .....	81
8. MAINTENANCE .....	82
8.1 Calibration .....	82
8.2 Information .....	82
8.3 Cleaning .....	82
8.4 Troubleshooting .....	83
8.5 Service Information .....	83
8.6 Software Updates .....	83
9. TECHNICAL DATA .....	84
9.1 Specifications .....	84
9.2 Drawings and Dimensions .....	85
9.3 Table of Geo Values .....	86
9.4 Options .....	87
9.5 Button Icons List .....	88
10. COMPLIANCE .....	92

## 1. INTRODUCTION

### 1.1 Description

The Ranger 7000 scale is a precision weighing instrument that will provide you with years of service if properly cared for. The Ohaus Ranger 7000 scales are available in capacities from 3000 grams to 60 kilograms.

### 1.2 Features

**Modular Design:** Ohaus Ranger 7000 scales are composed of two interconnected modules: a Terminal and a Base. Depending on the user's needs, the unit can be operated with the Terminal either attached to, or remote from, the Base, with a single interconnect cord 2 meter long. An optional tower kit and extended cord are also available as accessories.

### 1.3 Definition of Signal Warnings and Symbols

Safety notes are marked with signal words and warning symbols. These show safety issues and warnings. Ignoring the safety notes may lead to personal injury, damage to the instrument, malfunctions and false results.

#### Signal Words

<b>WARNING</b>	for a hazardous situation with medium risk, possibly resulting in injuries or death if not avoided.
<b>CAUTION</b>	for a hazardous situation with low risk, resulting in damage to the device or the property or in loss of data, or injuries if not avoided.
<b>Attention Note</b>	For important information about the product For useful information about the product

#### Warning Symbols



General Hazard



Electrical Shock Hazard



Alternating Current



Information

### 1.4 Safety Precautions









**Caution:** Read all safety warnings before installing, making connections, or servicing this equipment. Failure to comply with these warnings could result in personal injury and/or property damage. Retain all instructions for future reference.

- Verify that the input voltage range printed on the data label and the plug type matches the local AC power to be used.
- Only connect models supplied with a grounded power cord to a compatible grounded power receptacle.
- Do not position the scale such that it is difficult to disconnect the power cord from the power receptacle.
- Make sure that the power cord does not pose a potential obstacle or tripping hazard.
- This scale is for indoor use only.
- Use the scale in dry locations only.
- Do not drop loads on the pan.
- Use only approved accessories and peripherals.
- Operate the equipment only under ambient conditions specified in these instructions.
- Disconnect the equipment from the power supply when cleaning.
- Do not operate the equipment in hazardous or unstable environments.
- Service should only be performed by authorized personnel.

## 2. INSTALLATION

### 2.1 Unpacking

Carefully remove your Ranger 7000 scale and each of its components from the package. The included components vary depending on the scale model (see table below). Save the packaging to ensure safe storage and transport.

Included Component		Photo	R71MHD3 R71MHD6	R71MD3 R71MD6	R71MHD15 R71MHD35	R71MD15 R71MD35 R71MD60
Terminal			X	X	X	X
In-Use Cover			X	X	X	X
Weighing Base			X	X	X	X
Weighing Platform	210 x 210 mm		X			
Weighing Platform	280 x 280 mm			X		
Weighing Platform	311 x 371 mm				X	X
Wind Shield			X			
Compact Disc	Instruction Manual		X	X	X	X

## 2.2 Installing Components

Refer to the illustrations and instructions below to identify and assemble your Ranger 7000 scale with its components. All components must be assembled before using the scale.

### 2.2.1 Terminal Setup

When the Ranger 7000 is delivered, the Terminal is already attached (docked) to the Base. No additional setup is necessary. Refer to the illustrations and instructions below to identify and assemble your Ranger 7000 Scale.

**Note:** The Terminal is identical for all Ranger 7000 Scale models.

### 2.2.2 Installing the Wind Ring, Weighing Platform

1. Place the Wind Ring in position (R71MHD3, R71MHD6).
2. Place the platform onto the weighing base.

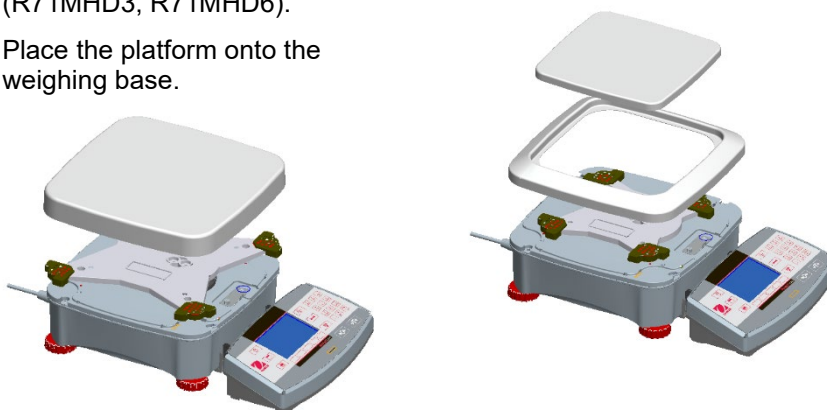

## 2.3 Selecting the Location

Avoid excessive vibrations, heat sources, air current, or rapid temperature changes. Allow sufficient space.

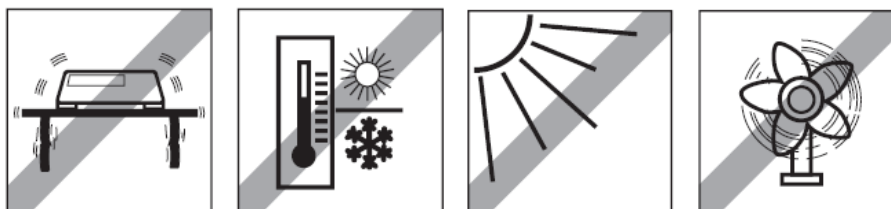

**Note:** Interface cables connect to the terminal. The terminal can be detached and mounted on a wall or positioned on a table separate from the scale.

## 2.4 Connecting Power and Turning ON the Scale

The Ranger 7000 comes with an AC power cord. Connect the power cord to a suitable grounded electrical outlet and press the ON button on the side of the base (see figure below).



Power ON button on the side of the base



**Attention:** Allow equipment to warm up for 60 minutes for optimal weighing performance.



### 2.5 Connecting the Interface

The Ranger 7000 scale has 4 interfaces on the back of the terminal:

- RS422: used to communicate with the base
- RS232: used to connect to computer or a printer
- USB host
- USB slave

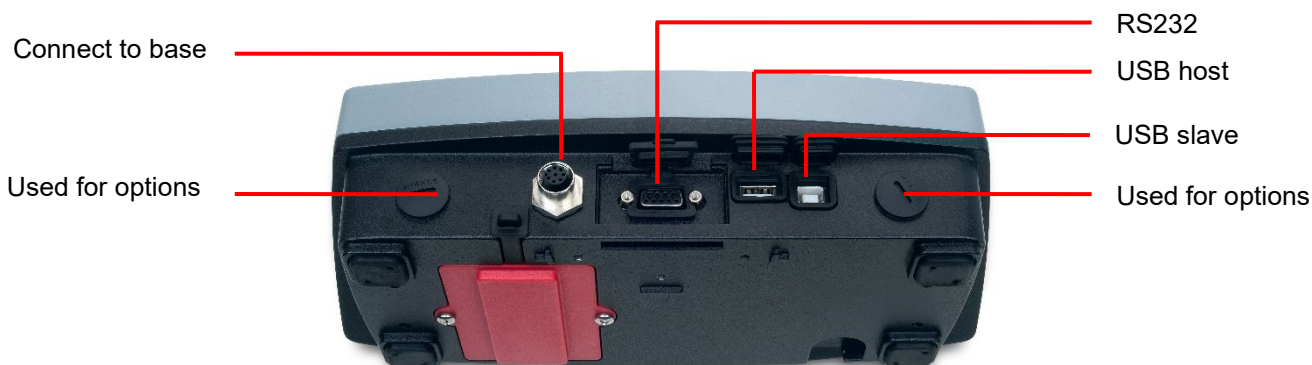

Interface connections on back of Terminal.



Thread terminal cable along cable coils on bottom of scale.  
Or pass cable through groove near release button.

### 2.6 Leveling the scale

Only scales that have been leveled precisely horizontally provide accurate weighing results. The certified scales have a spirit level to simplify alignment.

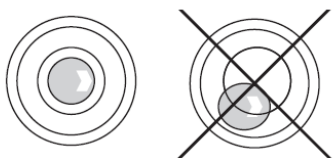

Turn the adjustable feet of the scale until the spirit level's air bubble is inside the inner circle.

### 2.7 Remote Terminal Operation

The Terminal communicates with the weighing base via the Terminal cable. This cable must be plugged into the Terminal for the Ranger 7000 to display properly. If desired, the Ranger 7000 scale may be operated either with the Terminal attached, or remotely (up to 1.5 meters away).

## 2.8 Separating the Terminal from the Weighing Base

1. To detach, press both the Release buttons inward (both at the same time) and gently pull the Terminal towards you (outward) until the Terminal is detached. These Release buttons disengage the two hooks holding the Terminal to the Base. A cable is attached to the Terminal. Take care to not damage or disconnect this cable.
2. To reattach the Terminal, press in the two Release buttons and slide the Terminal into the Base until the Terminal hooks click and engage to hold the Terminal in place.

Release Buttons

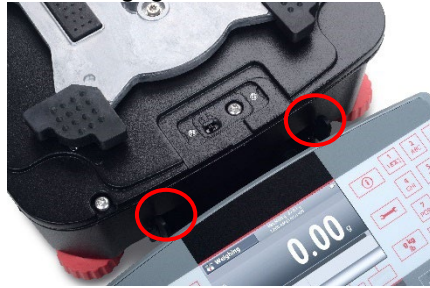

Base and Terminal



## 2.9 Terminal Mounting

If desired, the Terminal may be mounted to a wall or table using fasteners (not supplied) that are appropriate for the type of mounting surface.

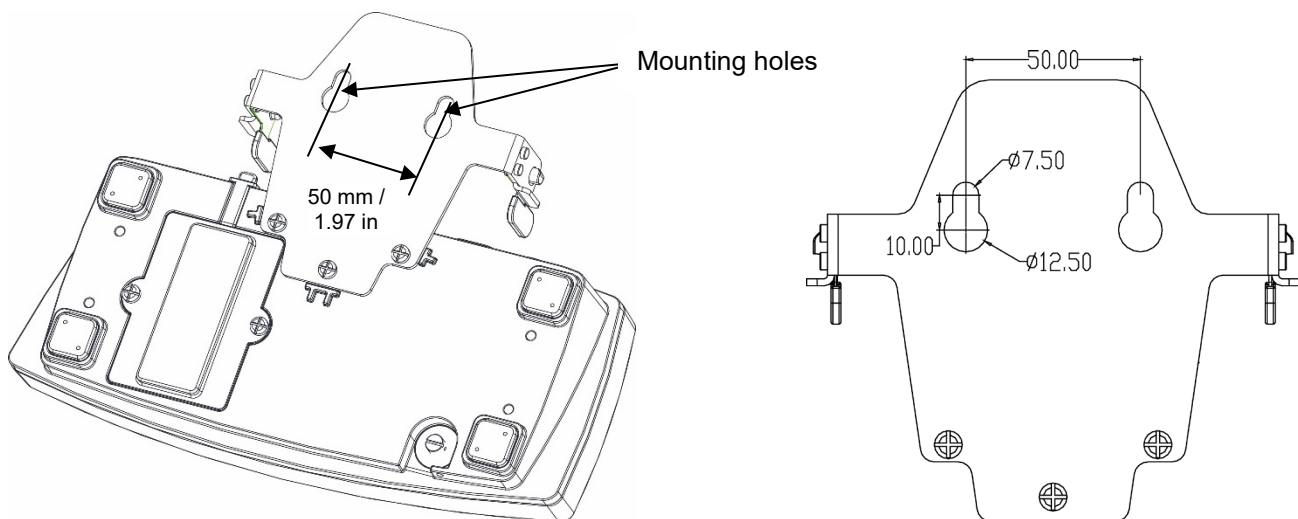

## 2.10 Initial Calibration

When the Scale is first installed, and when it is moved to another location, it must be calibrated to ensure accurate weighing results.

### 2.10.1 Internal calibration

R71MHD models have built in AutoCal which can calibrate the scale automatically and does not require calibration masses. If preferred, the scale can be manually calibrated with external masses. Have the appropriate calibration masses available before beginning calibration. Refer to the Calibration Section for masses and calibration procedure.

### 2.10.2 External calibration

R71MD models can only be manually calibrated with external masses.

### 3. OPERATION

#### 3.1 Overview of Display, Home Screen CONTROLS



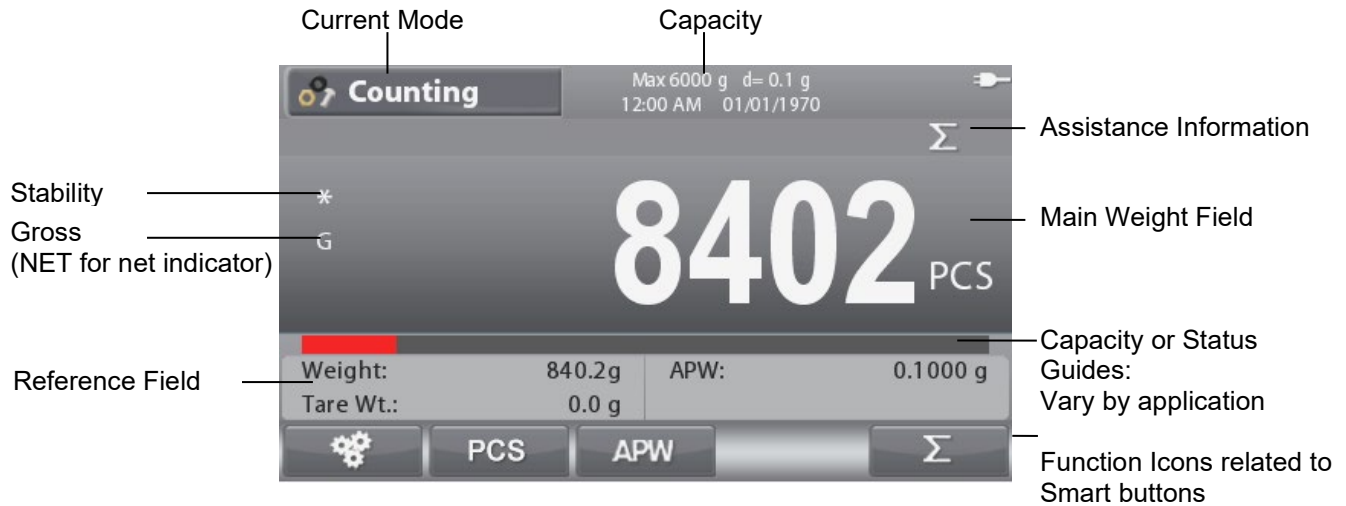

Button	Action
	Enter/Exit the library menu
	Switch between available application modes
	Send the measurement data to available communications ports according to current settings.
	Display information about Application Mode, Library, User and Menu
	Enter/Exit the User menu
	Switch the main weighing unit between the available units
	 Short Press: Input '2'-'9' To Enter 'A' press  2 times. For lower case 'Z', press  5 times.
	 Short Press: Input '0' Long Press: Go to User Login screen
	 Short Press: Input '1' Long Press: Switch platform between scale 1 and scale 2
	 Short Press: Clear character/string when editing string If no input is active, clear the current active library When there is no value added, pressing this button will switch the value sign between positive and negative.
	 Short Press: Input '.', space, '_' To Enter '_' press  3 times.
	Perform Zero operation
	Perform Tare operation When entering the value first and then pressing this button the number input will be set to preset Tare value.





### 3.2 Principal Functions and Main Menu

#### MENU & SCREEN NAVIGATION









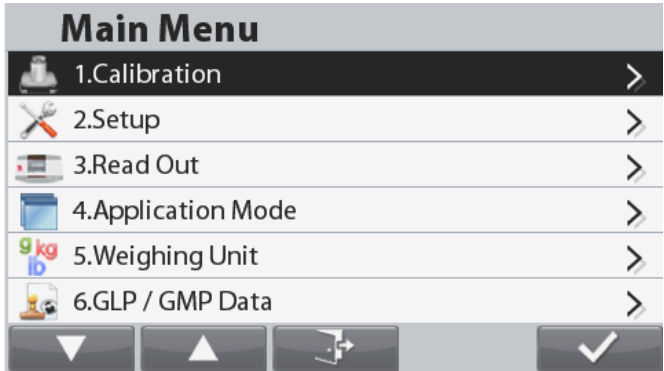

Press the **Menu**  button to open the menu list.

Press the button below  and  to move down and up the list respectively.

To select the highlighted menu item, press . Press  to move back to previous screen.

Alternatively, you can select each item through pressing the number on keyboard which is corresponding to the number before each item.

For example, press 1 on keyboard to select **Calibration**.

	<b>Calibration:</b> Select to view calibration options.		
	<b>Setup:</b> Select to view user preferences.		
	<b>Read Out:</b> Select to view scale settings.		
	<b>Application Modes:</b> Select to view application modes.		
	<b>Weighing Units:</b> Select to view weighing units.		
	<b>GLP and GMP Data:</b> Insert user data for traceability.		
	<b>Lock Key</b> Select to edit lock key settings		
	<b>Communication:</b> Select to view communication settings.		<b>Memory:</b> Select to view USB Memory and Alibi memory settings.
	<b>User</b> Select to view and edit user settings.		<b>Maintenance:</b> Select to view Maintenance settings.

## 3.3 Overview of Parts and Features



#### 4. APPLICATIONS

The scale can be configured to operate in various Application modes, see section 5.6 for information on how to activate/deactivate each application mode. Press  to select an activated application. The current application will be shown in the upper left corner of the home screen (See section 3.1).

The Ranger 7000 incorporates the following Applications



**Weighing**



**Counting**



**Check**



**Formulation**



**Percent Weighing**



**Filling**



**Dynamic (Animal)**



**Density Determination**



**Differential**



**Sieve Analysis**

**Note:** Before using any application, be sure the scale has been leveled and calibrated.

##### 4.1 Weighing

Use this application to determine the weight of items in the selected unit of measure.

Press the  button until **Weighing** is displayed in the upper left portion of the home screen (this application is the default).

Press **Tare** or **Zero** if necessary to begin.

Place objects on the pan to display the weight. When stable, the \* appears.

The resulting value is displayed in the main Weighing Line in the active unit of measure.



The **WEIGHING** Home screen

Main Display Line

Reference Fields

Functions



Application Icon

**Note:** Refer section 9.5, or press the  button for button icon explanation.





### 4.1.1 Application Setup

The Application can be customized for various user preferences.

Press the button corresponding to the  icon to enter **Configuration**.

The **Configuration** screen is now displayed.

Select the list item and press the button corresponding to , to change the setting as desired.

To return to the Application home screen, press the button corresponding to .

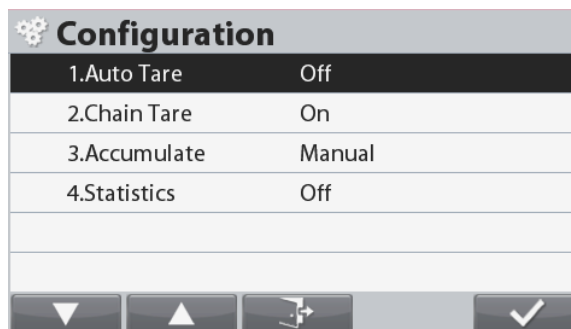

The Weighing Configurations are defined below (defaults in **Bold**)

Item	Available Settings	Comments
Auto Tare	On, <b>Off</b>	To enable Automatic Tare
Chain Tare	<b>On</b> , Off	To enable Chain (Continuous) Tare
Accumulate	Off, Automatic, <b>Manual</b>	To enable Accumulation / Totalization
Statistics	On, <b>Off</b>	To enable Statistics

### 4.1.2 Accumulation

To start Accumulate weighing data, place the item on the pan and press the button corresponding to the icon . The top accumulation icon will start blinking. The load to be accumulated has to be  $\geq 5d$  and the next accumulation can only start once the pan has been cleared.



**Note:** The Accumulation icon  will only be shown if Accumulate is set to Manual (see section 4.1.1).



#### Viewing the Statistics results

When Statistics is set to ON, press the info button  to view the statistics results.

#### Viewing the Accumulation results

To view the accumulation results, press the info button  then press the button corresponding to the icon .

The **Accumulate Result** screen is displayed.

**Note:** To return to home screen press the  button.

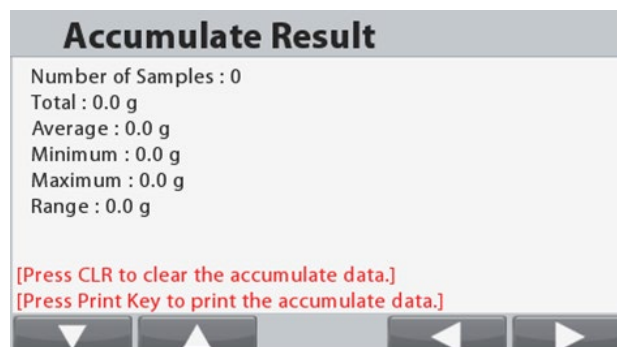

Press the  button to print Accumulation result.



**Clearing the Statistics / Accumulation results**

To clear the statistic / accumulation results, press the button



A warning message appears. Press the button  to confirm the deletion or press the button corresponding to the icon  to abort the deletion and return to previous screen.

**Note:** The accumulate/statistic information will be cleared automatically when selecting a new library

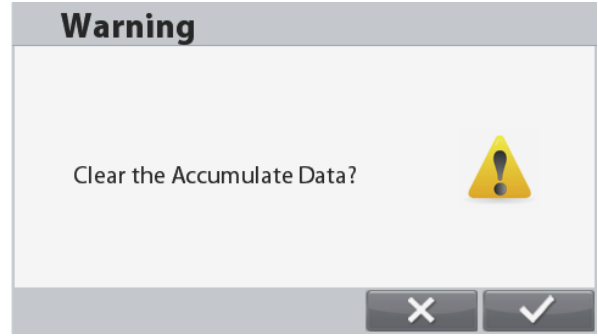

**4.1.3 Weighing ID**

To set up the weighing ID:

1. Press the button corresponding to the icon [ID].
2. Input the weighing ID and press the button corresponding to the icon  to confirm

The ID will be displayed on the screen.

**Note:** Only one ID can be stored in this function. New ID input would replace the previous data.

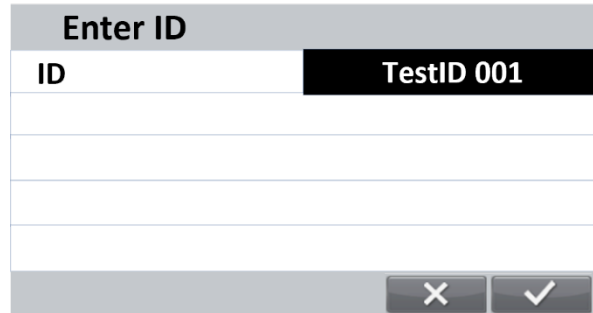

**4.1.4 Input/Output (I/O) Setup**

The I/O's can be customized for various user preferences.



The I/O's are defined below (defaults in **Bold**).

Item	Available Settings
Discrete Input 1	<b>Off</b> , Zero, Tare, Clear Tare, Print, Unit, Accumulate
Discrete Input 2	<b>Off</b> , Zero, Tare, Clear Tare, Print, Unit, Accumulate
Discrete Output 1	<b>Off</b> , Overload, Underload
Discrete Output 2	<b>Off</b> , Overload, Underload
Discrete Output 3	<b>Off</b> , Overload, Underload
Discrete Output 4	<b>Off</b> , Overload, Underload

**Note:** The I/O's will only work when the I/O Option Board have been installed. See the Accessory list in section 9.4 for information.

The option I/O board provides two isolated inputs and four dry-contact normally open relay outputs which can be used for simple process weighing.

Press the lock button to enter the Main Menu.

With the button corresponding to the  icon, go down the list and highlight **Application Mode**. Enter this sub-menu by pressing the button corresponding to the  icon.

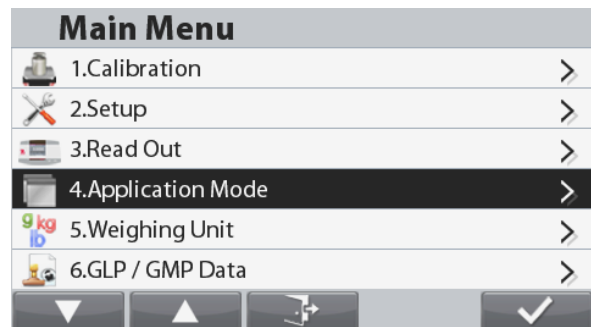



In the Application Mode menu enter the **Weighing** sub-menu.

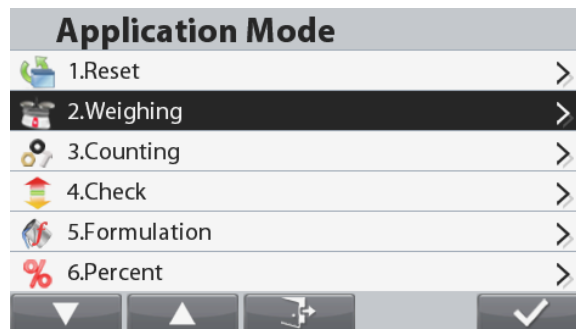

The Weighing sub-menu is now displayed. Select the list item and press the button corresponding to the  icon to change the setting as desired.

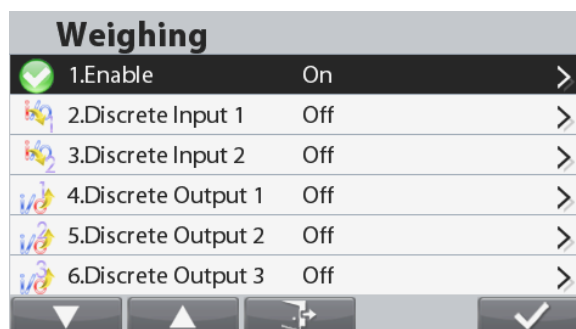

### 4.2 Counting

Use this application to count samples of uniform weight.

#### Counting

Press the  button until **Counting** is displayed in the upper left portion of the home screen. The default (or last) Average Piece Weight (APW) is displayed.

Setup APW value according to section 4.2.1 and then place objects on the pan to display the number of pieces.

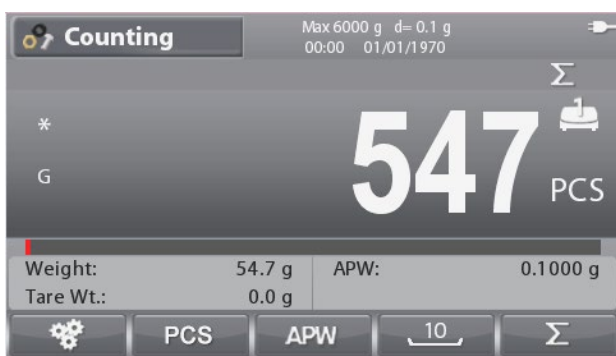

The **COUNTING** Home screen

Main Display Line

Reference Fields  
Functions



**Note:** Refer section 9.5, or press the  button for button icon explanation.



4.2.1 Set the Average Piece Weight (APW)

**Note:** It is recommended that the APW is larger than 1d. If APW is between 0.05d and 1d, a warning screen will be displayed and the information line will show 'Low APW'. If APW is less than 0.05d an error screen will appear and the APW value cannot be stored.

There are three ways to set the APW:

1. Positive Sampling

Place the sample on the pan and then key in the number of pieces using the alphanumerical keypad and press the button corresponding to the  icon to confirm.

Alternatively, press the button corresponding to the  icon. A numeric input screen appears. Key in the number of pieces using the alphanumerical keypad, then press the button corresponding to the .

The display returns to the Home screen.

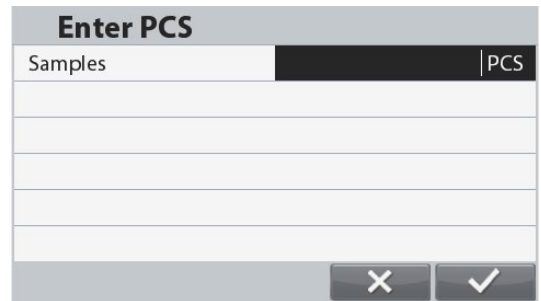



Place 10 pieces of sample on the pan and press the button corresponding to the icon  to perform sampling with default reference size.

**Note:**

The reference size can be changed in the Counting configuration.

2. Negative Sampling

Place container with the samples on the pan and Tare the scale, a NET 0 will be displayed. Remove the samples from the container; a negative net reading will be displayed. Input the sample size with the numeric keypad and then press the button corresponding to the icon . The value will be displayed on the screen.

Alternatively, press the button corresponding to the  icon.

A numeric input screen appears. Key in the desired number of pieces using the alphanumerical keypad, and then press the button corresponding to the  icon. The display returns to the Home screen.

Sampling can also be performed by pressing the button corresponding to the icon  with preset reference size.

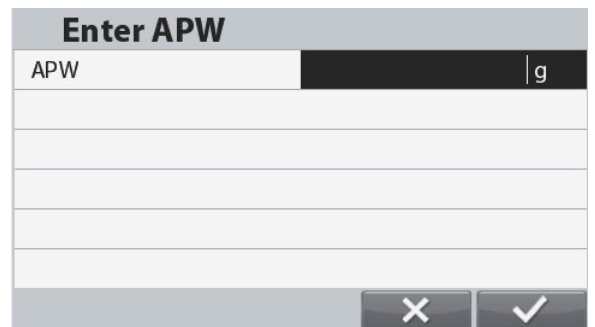
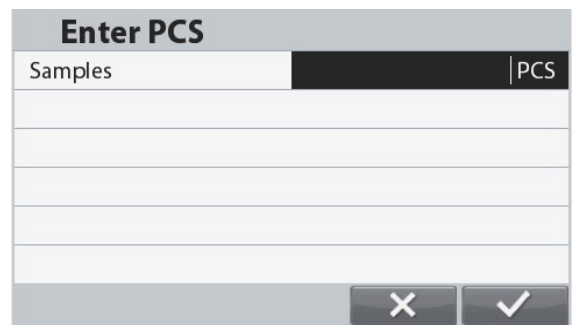

3. Entering a Known APW

Key in the Piece Weight using the alphanumerical keypad and press the button corresponding to the  icon to confirm and store the APW.

Alternatively, press the button corresponding to the  icon.

A numeric input screen appears.

Key in the Piece Weight using the alphanumerical keypad, then press the button corresponding to the  icon. The display returns to the Home screen with the new APW value displayed in the reference field.

**Notes:**

When current unit is metric (g, kg), APW unit is g.  
When current weighing unit is imperial (lb, oz), APW unit is lb.

4.2.2 Application Setup

The Application can be customized for various user preferences.

Press the button corresponding to the  icon to enter **Configuration**.



The **Configuration** screen is now displayed.

Select the list item and press the button corresponding to the  icon to change the setting as desired.

To return to the Application home screen, press the button corresponding to .

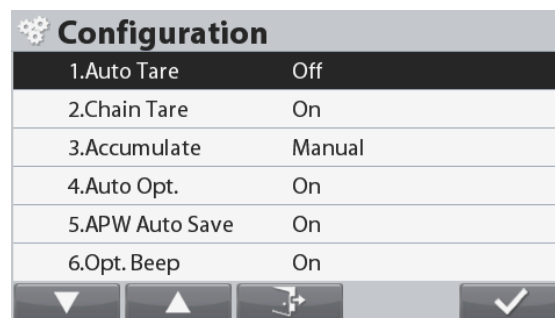

The Counting Configurations are defined below (defaults in **Bold**).

Item	Available Settings	Comments
Auto Tare	On, <b>Off</b>	Turns Automatic Tare on/off
Chain Tare	<b>On</b> , Off	To enable/disable Chain (Continuous)Tare
Accumulate	Off, Automatic, <b>Manual</b>	To enable/disable Accumulation / Totalization
Auto Opt.*	<b>On</b> , Off	To enable/disable Automatic Optimization of APW
APW Auto Save*	<b>On</b> , Off	To enable/disable APW Automatic save
Opt. Beep	<b>On</b> , Off	To enable/disable Optimization Beep
Internal Resolution	<b>On</b> , Off	To enable/disable internal counting resolution
Smart Sampling	<b>On</b> , Off	To enable/disable Smart Sampling
Reference Size	1... <b>10</b> ...999	Set Reference Size
Lock Reference Size	On, <b>Off</b>	To enable/disable the setting of Reference Size

**Note:** \* If APW value is directly entered (not through sampling) or calculated from the reference balance (displayed as APW(B)), this feature does not work.

### 4.2.3 Smart Sampling

When connected to reference balance or 2<sup>nd</sup> platform, smart sampling allow user to perform sampling without manually switching platforms.

#### When smart sampling is turned On

Sampling will always be performed from the reference balance (if reference balance is ON).

If reference balance is OFF, sampling will be performed from the main platform.



**Note:** Refer to section 5.9.7 on how to connect to reference balance.

#### Sampling Using Reference Balance

1. Place the samples on the reference balance.
2. Enter the piece number. You can do this in two ways:

- a) Key in the number of pieces using the alphanumerical keypad and press the button corresponding to the  icon to confirm.



- b) Alternatively, press the button corresponding to the  icon. A numeric input screen appears. Then, key in the number of pieces using the alphanumerical keypad, and then press the button corresponding to the  icon.

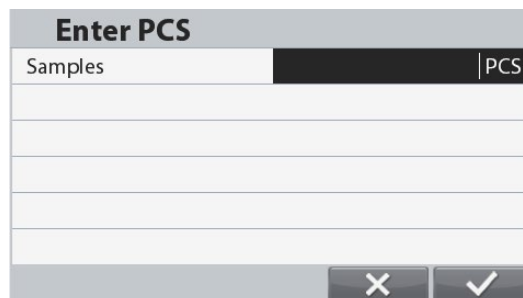

3. The APW will be displaced on the screen



#### Counting Using Reference Balance

To count with reference balance after sampling:

1. Place the objects on the reference balance
2. Read the count result from "Balance PCS.:"



#### When smart sampling is turned Off:

Sampling will be performed on the current platform.

4.2.4 Accumulation

See section 4.1.2 for details about the Accumulation feature.

4.2.5 Input/Output (I/O) Setup



The I/O's can be customized for various user preferences. The I/O's are defined below (defaults in **Bold**).

Item	Available Settings
Discrete Input 1	<b>Off</b> , Zero, Tare, Clear Tare, Print, Unit, Accumulate
Discrete Input 2	<b>Off</b> , Zero, Tare, Clear Tare, Print, Unit, Accumulate
Discrete Output 1	<b>Off</b> , Overload, Underload
Discrete Output 2	<b>Off</b> , Overload, Underload
Discrete Output 3	<b>Off</b> , Overload, Underload
Discrete Output 4	<b>Off</b> , Overload, Underload

**Note:** The I/O's will only work when the I/O Option Board have been installed. See the Accessory list in section 9.4 for information.

The option I/O board provides two isolated inputs and four dry-contact normally open relay outputs which can be used for simple process weighing.

Press the  button to enter the Main Menu.

With the button corresponding to the  icon, go down the list and highlight Application Mode. Enter this sub-menu by pressing the button corresponding to the  icon.

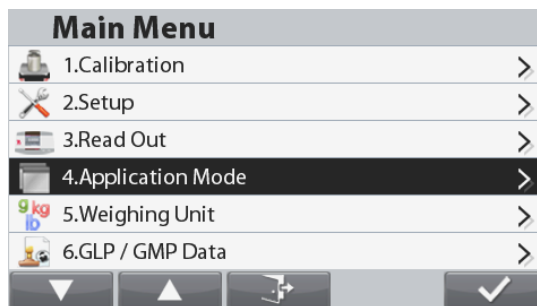

In the Application Mode menu enter the **Counting** sub-menu.

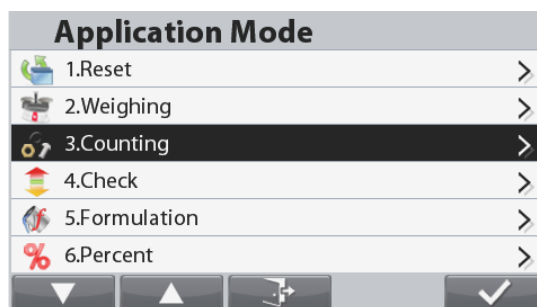

The Counting sub-menu is now displayed. Select the list item and press the button corresponding to the  icon to change the setting as desired.

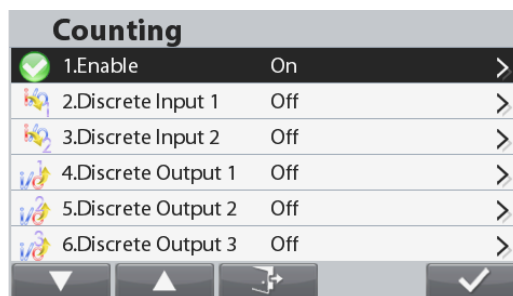

4.2.6 STR Scanning Process

Ranger 7000 supports STR scanning. For details, please refer [Ohaus STR Scanning Process](#).

### 4.3 Check

Check is used to compare the weight or pieces of a sample against target limits.

Press the  button until **Check** is displayed in the upper left portion of the home screen. Two different modes can be selected: Weight and Pieces.

Three different methods to enter the check limits: Over and Under, Nominal Weight Tolerance, or Nominal Percent Tolerance.

Setup check limits according to section 4.3.1 or 4.3.2. Place object on the pan to check if the weight is within the limits.

#### 4.3.1 Check Weighing (default)

Make sure that the check mode is set to check weighing in the configuration menu . Place objects on the pan. The **Under/Accept/Over** status is shown in the progress bar area while the actual weight of the item is shown on the main Display Line.



The **CHECK** Home screen

Main Display Line

Reference Fields  
Functions



Application Icon

**Note:** Refer section 9.5, or press the  button for button icon explanation.

#### Defining Over/Under Limits and Tolerance

Press the button corresponding to the  icon to enter **Limit Setup**.

Select Over or Under Limit and press the button corresponding to the  icon to edit the value.



Enter the desired value for the limit using the alphanumerical keypad. Then press the button corresponding to the  icon to set the value and go back to previous screen.



Alternatively, the limits can be set by Target Weight Tolerance.

To set the tolerance, press the button corresponding to the  icon to enter the **Tolerance setup**.





4.3.3 Application Setup

The Application can be customized for various user preferences.

Press the button corresponding to the  icon to enter **Configuration Setup**.





The **Configuration Menu** is now displayed.

Select the list item and press the button corresponding to , to change the setting as desired.

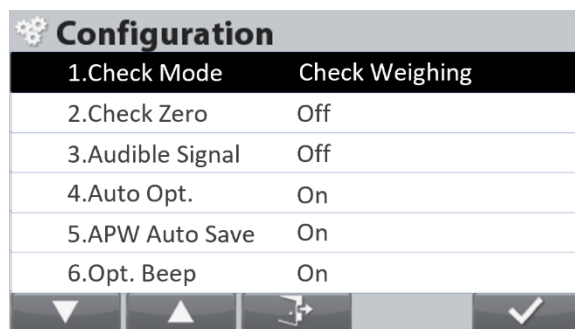
To return to the Application home screen, press the button corresponding to .



The display can be switched between **Block** and **Bar**. To do this, select **Graph Display** in the Configuration Menu. Press  and then press  or  to select.

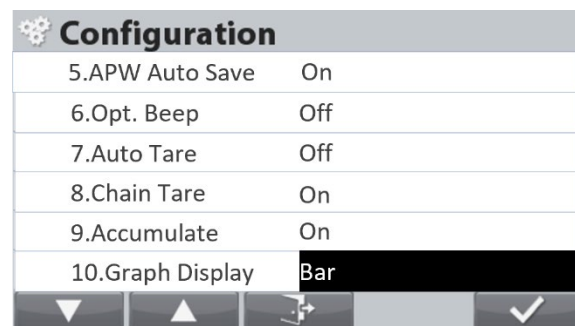

The Check Configurations are defined below (defaults in **Bold**).

Item	Available Settings	Comments
Check Mode	Check Weighing, Check Counting	To set Mode
Check Zero	On, Off	To enable check at zero point
Audible Signal	Off, Under,Accept,Over, Under&Over	To enable Beeper Signal
Auto Opt*	On, Off	To enable Automatic Optimization of APW
APW Auto Save*	On, Off	To enable APW Automatic save
Opt. Beep*	On, Off	To enable Optimization Beep
Auto Tare	On, Off, On Accept	To enable Automatic Tare 'On Accept' means that if the object weight is within accept range, auto Tare will be performed
Chain Tare	On, Off	To enable Chain (Continuous) Tare
Accumulate	Off, Automatic, Manual, On Accept	To enable Accumulation / Totalization 'On Accept' means that if the object weight is within accept range, auto Accumulate will be performed.
Graph Display	<b>Bar</b> , Block	To set Graph Display Type

Notes:

\* Only available in Check Counting mode.



- \* When the current unit is metric (g, kg), APW unit is g.
- \* When the current weighing unit is imperial (lb, oz), APW unit is lb.

**Positive Check**

Positive check is used to determine when the material added to the scale is within the target range. In this case the UNDER and OVER limits must be positive values. (The OVER limit must be greater than or equal to the UNDER limit.)

**Negative Check**

Negative check is used to determine when the material removed from the scale is within the target range. In this case the UNDER and OVER limits are both negative values.

The UNDER limit must be greater than or equal to the OVER limit (for example: UNDER= -10/OVER= -15).

Place the item to be weighed on the scale and press **Tare**.

Remove a portion of the item until it is within the ACCEPT range.

**Zero Check**

Zero check is used when comparing subsequent samples to an initial reference sample. In this case, the UNDER limit must be a negative value and the OVER limit must be a positive value.

Place the reference item on the scale and press **Tare**. Remove the reference sample and place the item to be compared on the scale to determine if it is within the ACCEPT range.

4.3.4 Input/Output (I/O) Setup



The I/O's can be customized for various user preferences.

The I/O's are defined below (defaults in **Bold**).

Item	Available Settings
Discrete Input 1	<b>Off</b> , Zero, Tare, Clear Tare, Print, Unit, Accumulate
Discrete Input 2	<b>Off</b> , Zero, Tare, Clear Tare, Print, Unit, Accumulate
Discrete Output 1	<b>Off</b> , Under, Over, Accept, Under/Over
Discrete Output 2	<b>Off</b> , Under, Over, Accept, Under/Over
Discrete Output 3	<b>Off</b> , Under, Over, Accept, Under/Over
Discrete Output 4	<b>Off</b> , Under, Over, Accept, Under/Over

**Note:** The I/O's will only work when the I/O Option Board have been installed. See the Accessory list in section 9.4 for information. The option I/O board provides two isolated inputs and four dry-contact normally open relay outputs which can be used for simple process weighing.

Press the  button to enter the Main Menu.

With the button corresponding to the  icon, go down the list and highlight **Application Mode**. Enter this sub-menu by pressing the button corresponding to the  icon.

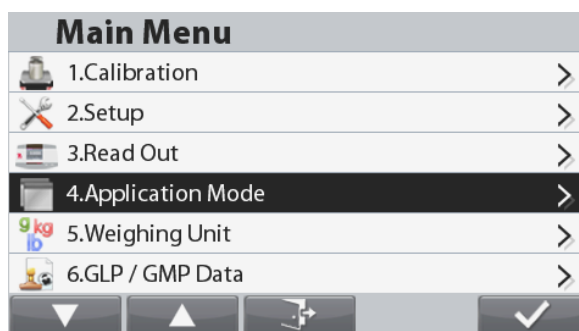

In the Application Mode menu enter the **Check** sub-menu.



The Check sub-menu is now displayed.  
Select the list item and press the button corresponding to the  icon to change the setting as desired.

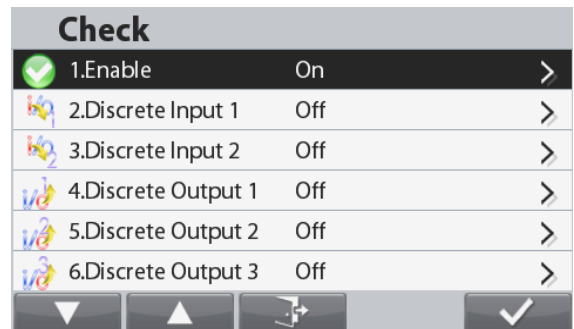

### 4.4 Formulation

Use this application for compounding and recipe making. The number of components can be 1 to 100. Formulation has two available modes of operation: **Free Formulation** and **Recipe Formulation**.

Press the  button until **Formulation** is displayed in the upper left portion of the home screen.

#### 4.4.1 Free Formulation (default)

This mode of Formulation allows the user to freely add components. A recipe can also be saved and printed when the formulation is finished.



The **FORMULATION** Home screen

Main Display Line

Reference Fields

Functions



Application Icon

**Note:** Refer section 9.5, or press the  button for button icon explanation.

Press the button corresponding to the  icon to enter the Enter Component screen.

Select the list item and press the button corresponding to the icon , to change the value as desired using the alphanumerical keypad. The item Name and The item Name and target Weight are required to be entered.

If you have another platform, you can input which platform to use here.

Press the button corresponding to the icon  to confirm all the values and continue with the formulation.

**Note:** The  icon will only appear when all the required values have been entered (name and target weight).

The entered target weight will be used as preset tare.

Place the required weight on the pan (add weight until the displayed value reaches zero again).

When weight matches the tolerance range of the target weight, the display digits will be highlighted. When the displayed value reaches zero, the scale beeps once.

The color signal would visually indicate the formulation status:

- Yellow: Under target
- Green: Meet target
- Red: Over target



Press the button corresponding to the icon  to confirm the weight for the current component and to continue adding other components.

**Notes:** To terminate the formulation process, press the button corresponding to the  icon. If the added weight is over the tolerance limit, compensation will be performed according to the setup in the configuration (At the end, Off, Immediately).

When the compensation is active (At the end or Immediately), if the component added is within tolerance the color signal is always in green color.

If one component added is outside the tolerance, the scale will do compensation for next items. In this case, the value displayed is not actual weight and the color signal will turn red.

To finish the formulation, press the button corresponding to the icon  and add the last component.

Then the formulation will finish and a Formulation Result screen is displayed.

Formulation Result				
Item	PN	Name	Formu. Wt.	Actual Wt.
001	11	comp.1	50.0	51.3

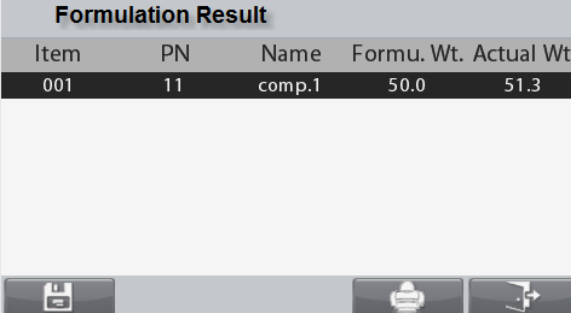

To print the formulation result press the button corresponding to the icon  or the button .

To save the formulation result, press the button corresponding to the icon .

To return to the main screen, press the button corresponding to the icon .

#### 4.4.2 Recipe Formulation

Make sure the formulation mode is set to recipe (see section 4.4.4 for instructions).

The information line will now show 'Please recall a recipe'

Recall a recipe from the Formulation Library by pressing the button . See section 4.11 for instructions on how to create/recall a Library record.







## 4.4.4 Application Setup

The Application can be customized for various user preferences.

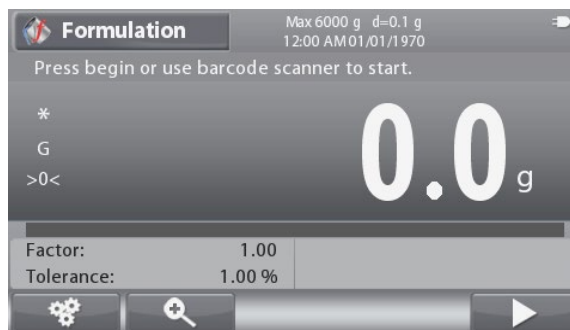
Press the button corresponding to the  icon to enter **Configuration**.



The **Configuration Menu** is now displayed.

Select the list item and press the button corresponding to , to change the setting as desired.

To return to the Application home screen, press the button corresponding to .

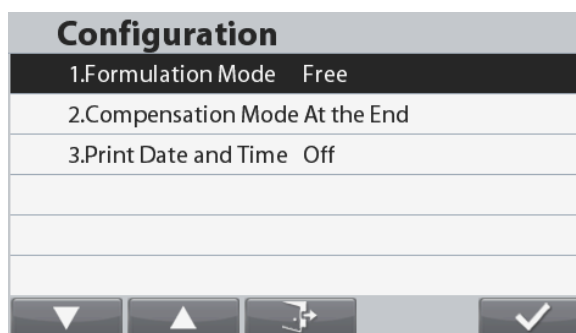

The **Formulation Configurations** are defined below (defaults in **Bold**).

Item	Available Settings	Comments
Formulation Mode	<b>Free</b> , Recipe	To set Mode
Compensation Mode	<b>At the End</b> , Off, Immediately	To set compensation mode
Print Date and Time	<b>Off</b> , on	To turn on or off print date and time

## 4.4.5 Input/Output (I/O) Setup



The I/O's can be customized for various user preferences.

The I/O's are defined below (defaults in **Bold**).

**Note:** The I/O's will only work when the I/O Option Board have been installed. See the Accessory list in section 9.4 for information. The option I/O board provides two isolated inputs and four dry-contact normally open relay outputs which can be used for simple process weighing.

Item	Available Settings
Discrete Input 1	<b>Off</b> , Zero, Tare, Clear Tare, Quit, Next Item, Last Item
Discrete Input 2	<b>Off</b> , Zero, Tare, Clear Tare, Quit, Next Item, Last Item
Discrete Output 1	<b>Off</b> , Overload, Underload
Discrete Output 2	<b>Off</b> , Overload, Underload
Discrete Output 3	<b>Off</b> , Overload, Underload
Discrete Output 4	<b>Off</b> , Overload, Underload

Press the  button to enter the Main Menu.

With the button corresponding to the  icon, go down the list and highlight **Application Mode**. Enter this sub-menu by pressing the button corresponding to the  icon.

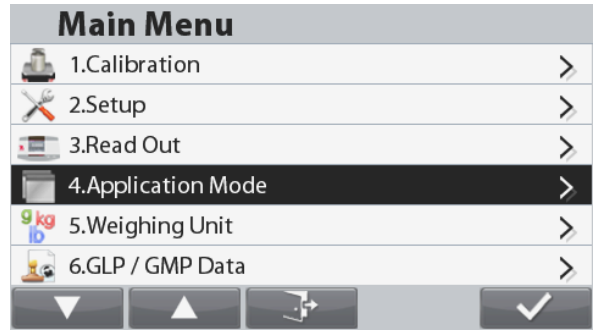

In the Application Mode menu enter the **Formulation** sub-menu.



The Formulation sub-menu is now displayed. Select the list item and press the button corresponding to the  icon to change the setting as desired.

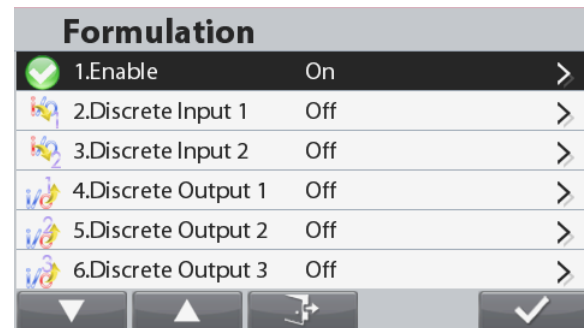

### 4.5 Percent Weighing

Use Percent Weighing to measure the weight of a sample displayed as a percentage of a pre-established Reference Weight.

Press the  button until **Percent** is displayed in the upper left portion of the home screen.

Establish a reference weight according to section 4.5.1 and then place the objects on the pan to check the percentage.

The default (or last) Reference Weight is displayed.



The **PERCENT** Home screen

Main Display Line

Reference Fields

Functions



Application Icon

**Note:** Refer section 9.5, or press the  button for button icon explanation.

4.5.1 Establishing a Reference Weight

There are three ways to establish a reference weight:

1. Key in the reference weight value using the alphanumerical keypad and then press the button corresponding to the  icon.





2. Press the button corresponding to the  icon to enter the **Edit Reference Weight** screen.

The **Edit Reference Weight** screen is now displayed.

Enter the desired value using the alphanumerical keypad and then press the button corresponding to

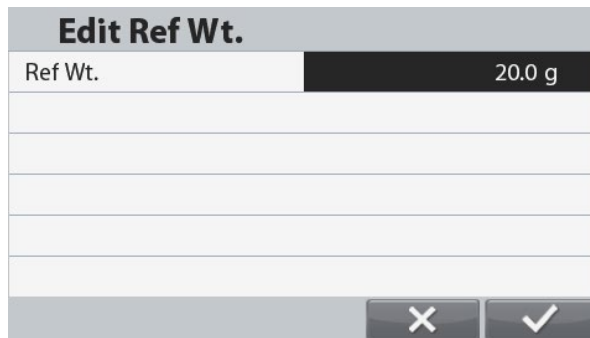
the  icon to save and return to the Application home screen.



3. Place the reference weight on the pan and press the button corresponding to the  icon.

4.5.2 Application Setup

The Application can be customized for various user preferences.

Press the button corresponding to the  icon to enter **Configuration**.



The **Configuration Menu** is now displayed.

Select the list item and press the button corresponding to , to change the setting as desired.

To return to the Application home screen, press the button corresponding to .





The Percent Configurations are defined below (defaults in **Bold**).

Item	Available Settings	Comments
Auto Tare	On, <b>Off</b>	To enable Automatic Tare
Chain Tare	<b>On</b> , Off	To enable Chain Tare (continuous Tare)
Accumulate	<b>Off</b> , Automatic, Manual	To enter Accumulation / Totalization

### 4.6 Filling

This application allows the user to fill a container to a pre-determined target weight. The progress bar displays the filling status, and within 10 percent of the target value the progress bar converts to fine resolution (+/- 10%) for accurate results.

Press the  button until **Filling** is displayed in the upper left portion of the home screen.

Two different modes can be selected: Weighing Filling and Parts Filling.

#### 4.6.1 Weight Filling

Make sure that the filling mode is set to Weight Filling in the configuration menu . The default (or last) Target weight is displayed. Place objects on the pan to begin.



The Weight Filling Home screen

Main Display Line

Reference Fields  
Functions



Application Icon

**Note:** Refer section 9.5, or press the  button for button icon explanation.







**Set the Average Piece Weight (APW)**

**Note:** It is recommended that the APW is larger than 1d. If APW is between 0.05d and 1d, a warning screen will be displayed and the information line will show 'Low APW'. If APW is less than 0.05d an error screen will appear and the APW value cannot be stored.

There are three ways to set the APW:

**1. Positive Sampling**

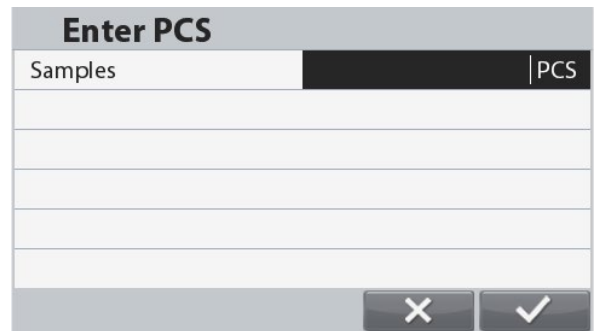

Place the sample on the pan and then key in the number of pieces using the alphanumerical keypad and long press the button corresponding to the  icon to confirm.

Alternatively, long press the button corresponding to the  icon. A numeric input screen appears. Key in the desired number of pieces using the alphanumerical keypad, and then press the button corresponding to the  icon. The display returns to the Home screen.





**2. Negative Sampling**

Place container with the samples on the pan and Tare the scale, a NET 0 will be displayed. Remove the samples from the container; a negative net reading will be displayed. Input the sample size with the numeric keypad and then long press the button corresponding to the icon . The value will be displayed on the screen.

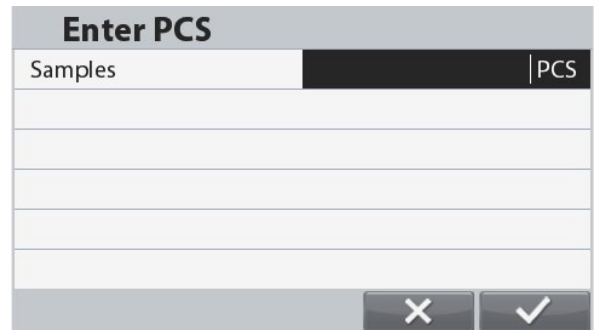
Alternatively, long press the button corresponding to the  icon. A numeric input screen appears. Key in the desired number of pieces using the alphanumerical keypad, and then press the button corresponding to the  icon. The display returns to the Home screen.





**3. Entering a Known APW**

Key in the Piece Weight using the alphanumerical keypad and long press the button corresponding to the  icon to confirm and store the APW. Alternatively, long press the button corresponding to the  icon. A numeric input screen appears. Key in the Piece Weight using the alphanumerical keypad, then press the button corresponding to the  icon. The display returns to the Home screen with the new APW value displayed in the reference field.

**Notes:**  
 When current unit is metric (g, kg), APW unit is g.  
 When current weighing unit is imperial (lb, oz), APW unit is lb.



**Pause and Continue**

If you need to pause after you start weighing, you can press the  button. During that period, weighing won't be updated. To continue, press the  button again.

If you need to stop after you start weighing, you can press the  button. The weighing process will go back to the beginning, but your previous weighing result will be kept.

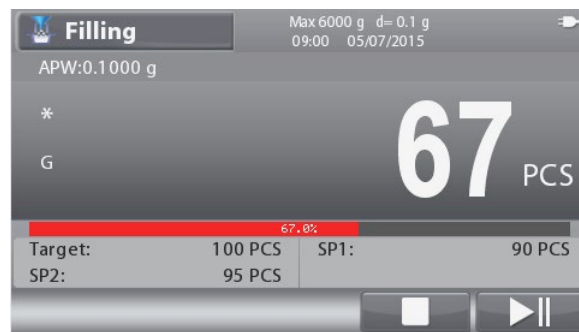

4.6.3 Application Setup

The Application can be customized for various user preferences.

Press the button corresponding to the  icon to enter **Configuration**.



The **Configuration Menu** is now displayed.

Select the list item and press the button corresponding to the icon , to change the setting as desired.

To return to the Application home screen, press the button corresponding to the icon .

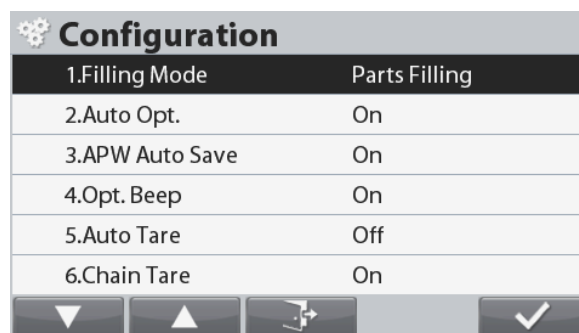

The **Filling Configurations** are defined below (defaults in **Bold**).

Item	Available Settings	Comments
Auto Tare	On, <b>Off</b>	To enable Automatic Tare
Chain Tare	<b>On</b> , Off	To enable Chain Tare (Continuous Tare)
Accumulate	<b>Off</b> , Manual	To enable Accumulation / Totalization
Filling Mode	<b>Filling Weighing</b> ; Filling Counting	To select between different filling modes.
Auto Opt.	<b>On</b> , Off	To enable Automatic Optimization of APW
APW Auto Save	<b>On</b> , Off	To enable APW Automatic save
Opt.Beep	<b>On</b> , Off	To enable Optimization Beep

4.6.4 Input/Output (I/O) Setup

The I/O's can be customized for various user preferences.  
 The I/O's are defined below (defaults in **Bold**).

Item	Available Settings
Discrete Input 1	<b>Off</b> , Zero, Tare, Clear Tare, Print, Start/Stop, Pause/Continue
Discrete Input 2	<b>Off</b> , Zero, Tare, Clear Tare, Print, Start/Stop, Pause/Continue
Discrete Output 1	<b>Off</b> , SP1, SP2, Target, Alarm
Discrete Output 2	<b>Off</b> , SP1, SP2, Target, Alarm
Discrete Output 3	<b>Off</b> , SP1, SP2, Target, Alarm
Discrete Output 4	<b>Off</b> , SP1, SP2, Target, Alarm



**Note:**

The output will be reset to normally open when both SP1 and SP2 are reached.

The I/O's will only work when the I/O Option Board have been installed. See the Accessory list in section 9.4 for information. The option I/O board provides two isolated inputs and four dry-contact normally open relay outputs which can be used for simple process weighing.

The outputs also only work when the button corresponding to the icon  has been pressed.

Press the  button to enter the Main Menu.

With the button corresponding to the  icon, go down the list and highlight **Application Mode**. Enter this sub-menu by pressing the button corresponding to the  icon.

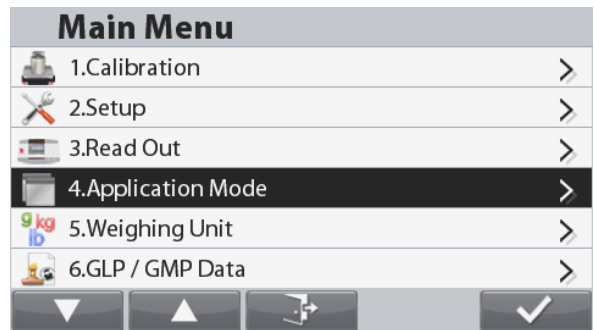

In the Application Mode menu enter the **Filling** sub-menu.

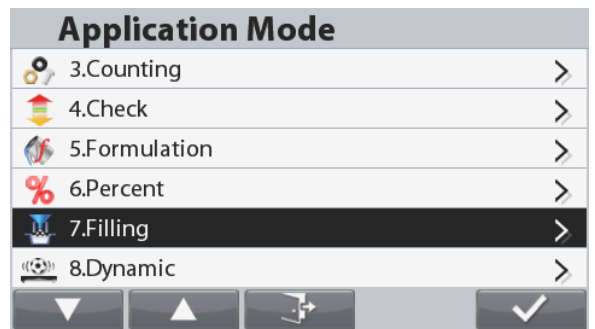

The Filling sub-menu is now displayed.  
 Select the list item and press the button corresponding to the  icon to change the setting as desired.

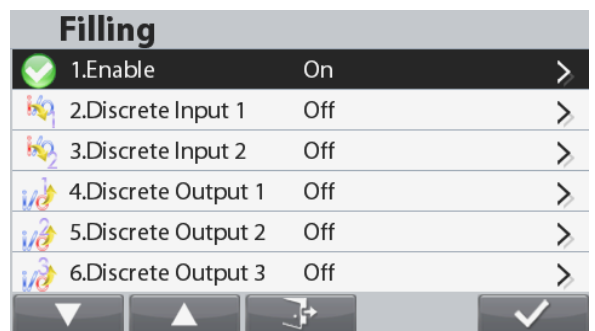

### 4.7 Dynamic Weighing

Use this application to weigh an unstable load, such as a moving animal. Three different start/reset modes can be selected: Manual (start and stop via key press), **Semi-Automatic** (auto-start with manual reset), and **Automatic** (start and stop automatically).

Press the  button until **Dynamic** is displayed in the upper left portion of the home screen.

Press the button corresponding to the icon  to start averaging.

To abort the averaging press the button corresponding to the icon .

When the averaging has finished, press the button corresponding to the icon  to reset.



The **DYNAMIC** Home screen

Main Display Line

Reference Fields  
Functions



Application Icon

**Note:** Refer section 9.5, or press the  button for button icon explanation.

4.7.1 Application Setup

The Application can be customized for various user preferences.

Press the button corresponding to the  icon to enter **Application Setup**.

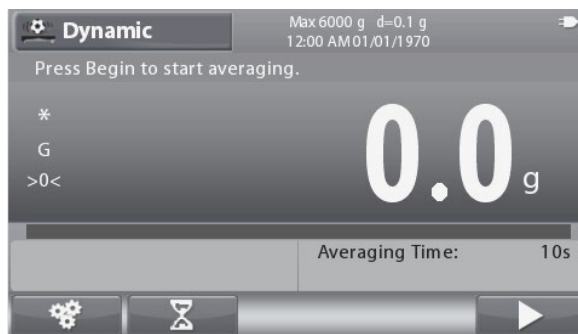

The **Configuration Menu** is now displayed.

Select the list item and press the button corresponding to , to change the setting as desired.

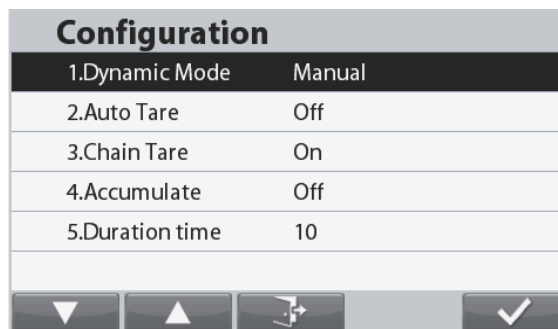

To return to the Application home screen, press the button corresponding to .

The **Dynamic Configurations are defined below** (defaults in **Bold**).

Item	Available Settings	Comments
Dynamic Mode	<b>Manual</b> , Semi-Automatic, Automatic	To set the Mode
Auto Tare	On, <b>Off</b>	To enable Automatic Tare
Chain Tare	<b>On</b> , Off	To enable Chain (Continuous) Tare
Accumulate	<b>Off</b> , Automatic, Manual	To enable Accumulate / Totalization
Duration Time	1... <b>10 S</b>	Set the duration time in seconds

4.7.2 Average Time Setup

Press the button corresponding to the  icon to enter the **Edit Average Time** screen.

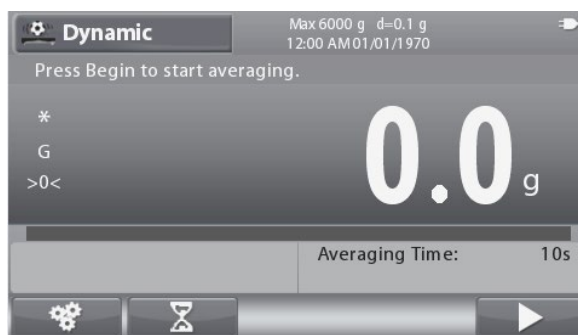

The **Edit Average Time** screen is now displayed.

Enter the Average Time by using the alphanumerical keypad and press the button corresponding to the  icon to change save the value and return to the Application home screen.

The default Average Time is 10 s.

**Note:** When the time is set to 0, the first stable weight over 5d will be displayed.

Averaging time can be set to a value between 0

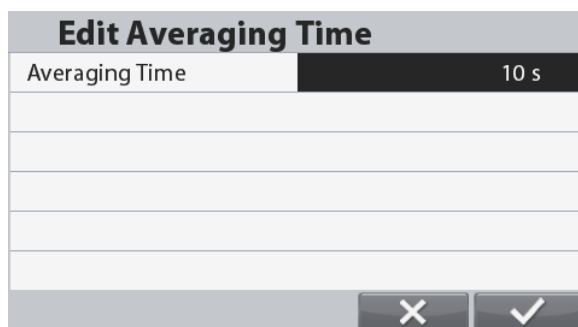



and 60.



4.7.3 Input/Output (I/O) Setup

The I/O's can be customized for various user preferences. The I/O's are defined below (defaults in **Bold**).

Item	Available Settings
Discrete Input 1	<b>Off</b> , Zero, Tare, Clear Tare, Print, Start, Reset
Discrete Input 2	<b>Off</b> , Zero, Tare, Clear Tare, Print, Start, Reset
Discrete Output 1	<b>Off</b> , Underload, Overload
Discrete Output 2	<b>Off</b> , Underload, Overload
Discrete Output 3	<b>Off</b> , Underload, Overload
Discrete Output 4	<b>Off</b> , Underload, Overload

**Note:** The I/O's will only work when the I/O Option Board have been installed. See the Accessory list in section 9.4 for information. The option I/O board provides two isolated inputs and four dry-contact normally open relay outputs which can be used for simple process weighing.

Press the  button to enter the Main Menu.

With the button corresponding to the  icon, go down the list and highlight **Application Mode**. Enter this sub-menu by pressing the button corresponding to the  icon.

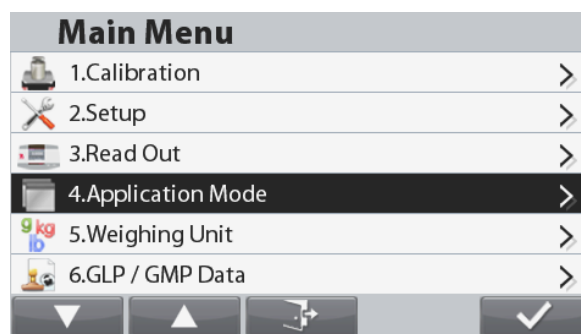

In the Application Mode menu enter the **Dynamic** sub-menu.

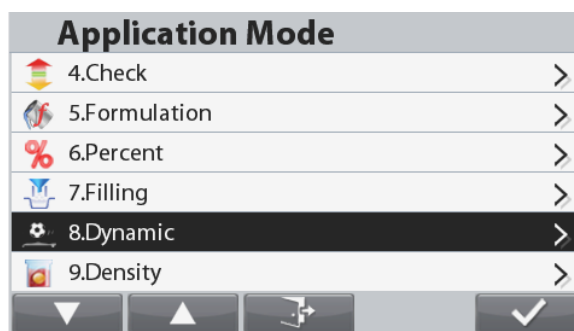

The Dynamic sub-menu is now displayed. Select the list item and press the button corresponding to the  icon to change the setting as desired.

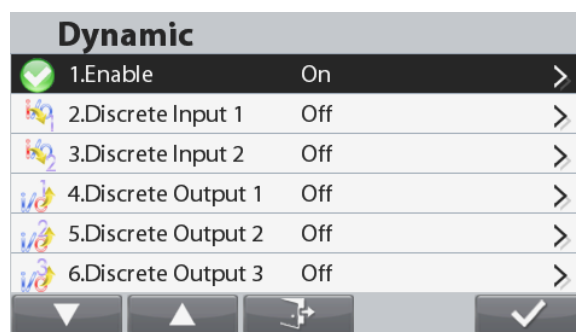

### 4.8 Density Determination

The Ranger 7000 can be used to determine an object's density. Two types of density determination can be made:

1. Solids *more* dense than water
2. Solids *less* dense than water

Press the  button until **Density** is displayed in the upper left portion of the home screen.

Before making density measurements, establish the Application Settings.

Press the button corresponding to the icon  to start.

Check the object weight in air and when prompted press the button corresponding to the icon .

Check the object weight again when it is submerged in the liquid and when prompted press the button corresponding to the icon . The density of the object will be displayed.



The **DENSITY** Home screen

Main Display Line

Reference Fields  
Functions



Application Icon

**Notes:**

Refer section 9.5, or press the  button for button icon explanation.

#### 4.8.1 Application Setup

The Application can be customized for various user preferences.

Press the button corresponding to the  icon to enter **Configuration**.



The **Configuration Menu** is now displayed.

Select the list item and press the button corresponding to , to change the setting as desired.

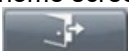
To return to the Application home screen, press the button corresponding to .

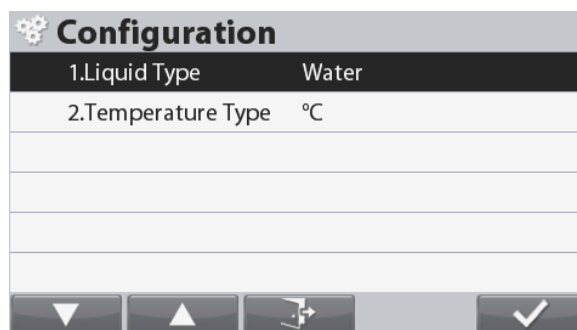

The Density Determination Configurations are defined below (defaults in **Bold**).

Item	Available Settings	Comments
Liquid Type	<b>Water</b> , Other*	To set the Liquid type
Temperature Type	<b>°C</b> , °F	To set the Temperature Type

**Note:** \* Other liquids that are not water.

#### 4.8.2 Water Temperature / Liquid Density Setup

To set the water temperature or Liquid density (other liquids than water), please follow the instructions below.

##### Liquid type: Water

Press the button corresponding to the  icon to enter the **Enter Water Temperature** screen.



The **Enter Water Temperature** screen is now displayed.

Enter the water temperature by using the alphanumerical keypad and press the button corresponding to the  icon, to save the value and return to the previous screen.

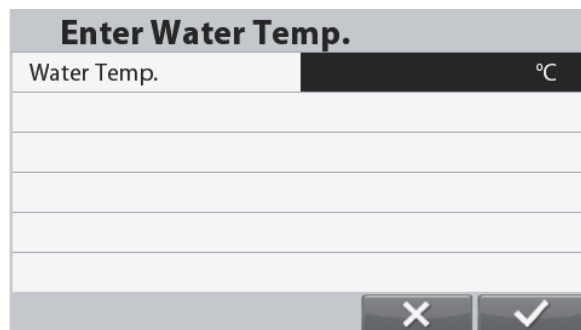

##### Liquid Type: Other

Press the button corresponding to the  icon to enter the **Enter Liquid Density** screen.



The **Enter Liquid Density** screen is now displayed.

Enter the liquid density by using the alphanumerical keypad and press the button corresponding to the  icon, to save the value and return to the previous screen.

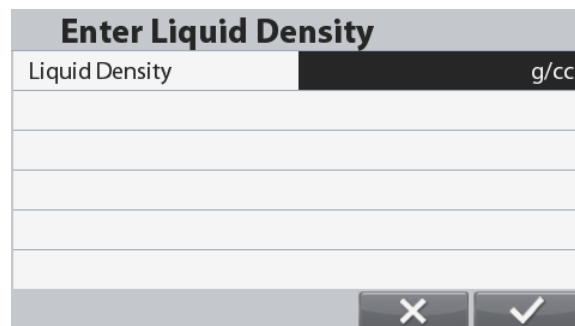

### 4.9 Differential Weighing

Differential weighing stores weight values of the samples. The samples can then be dried or processed and the difference in weight calculated. Up to 20 samples can be stored.

Press the  Button until **Differential** is displayed in the upper left portion of the home screen.

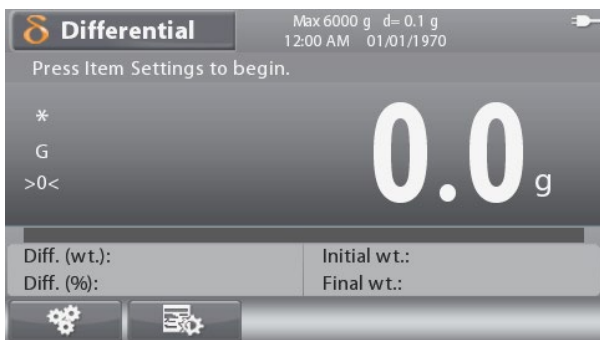

The **DIFFERENTIAL** Home screen

Main Display Line

Reference Fields  
Functions



Application Icon

**Note:** Refer section 9.5, or press the  button for button icon explanation.

#### 4.9.1 Application Setup

The Application can be customized for various user preferences.

Press the button corresponding to the  icon to enter **Configuration**.

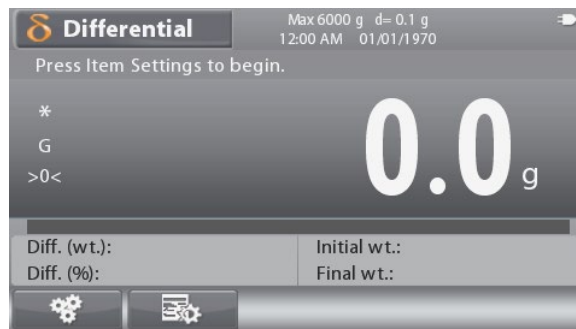

The **Configuration Menu** is now displayed.

Select the list item and press the button corresponding to , to change the setting as desired.

To return to the Application home screen, press the button corresponding to .



The **Differential Configurations** are defined below (defaults in **Bold**).

Item	Available Settings	Comments
Auto Tare	<b>Off</b> , On	To set the Automatic Tare
Chain Tare	<b>On</b> , Off	To set the Chain Tare

4.9.2 Differential Operation

To start differential, please follow the instructions below.

Press the button corresponding to the  icon to enter **Edit Item**.

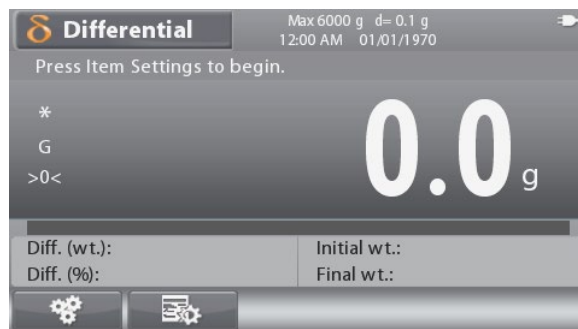

The **Edit Item Menu** is now displayed

Press  to add a new item. A maximum of 20 items can be created.

Press , the current item is selected and the scale returns to the main screen to start differential weighing.

Press  to edit the name of the item.

**Note:** All data will automatically be cleared when scale is powered Off.  
An item must be selected to start differential operation.

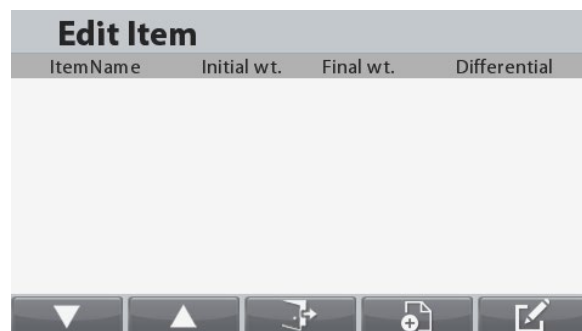

4.10 Sieve Weighing

Sieve analysis (or gradation test) is a practice or procedure used to assess the particle size distribution (also called gradation) of a granular material. It can be performed on any type of non-organic or organic granular materials including sands, crushed rock and aggregates, clays, granite, feldspars, asphalt, concrete, coal, soil, as well as a wide range of manufactured powders, grain and seeds.

Press the  Button until **Sieve** is displayed in the upper left portion of the home screen.



The **SIEVE** Home screen

Main Display Line

Reference Fields  
Functions



Application Icon

**Note:** Refer section 9.5, or press the  button for button icon explanation.

4.10.1 Application Setup

The Application can be customized for various user preferences.

Press the button corresponding to the  icon to enter **Configuration**.



The **Configuration Menu** is now displayed.

Select the list item and press the button corresponding to the  icon, to change the setting as desired.

To return to the Application home screen, press the button corresponding to the  icon.

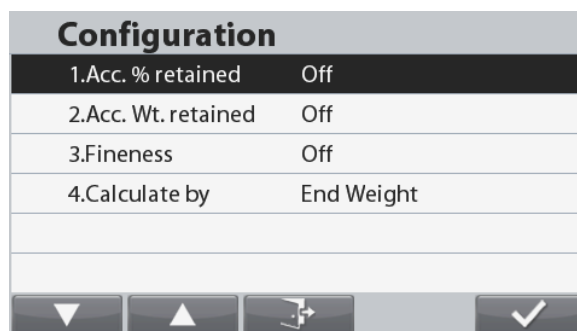

The Sieve Configurations are defined below (defaults in **Bold**).

Item	Available Settings	Comments
Acc. % retained	<b>Off</b> , On	Print Accumulated % retained (on / off)
Acc. Wt. retained	<b>Off</b> , On	Print Accumulated weight retained (on / off)
Fineness	<b>Off</b> , On	Print Fineness Modulus (on / off)
Calculate by	<b>End Weight</b> , Start Weight	Calculate result with End Weight or Start Weight

**Note:** \* If Start Weight is chosen, you must weigh original sample (or input manually).

4.10.2 Sieve Operation

To start sieve operation, please follow the instructions below.

Recall a sieve set from library to begin.

**Note:** A sieve set must be in library for the sieve application to work. Each Sieve to be used has to be added to the set, even if they are not used for Fineness Modulus calculation, as well as the Pan (with mm size 0). Sieve Weighing always assumes that the procedure will be from the grossest sieve (largest size) down to the finest sieve (the pan). To create a sieve set, see section 4.11.



Press the button corresponding to the  icon to start Sieve weighing.



Enter a sample ID if needed.

**Note:** The sample ID can be up to 30 alphanumeric characters and can be printed on the output template.

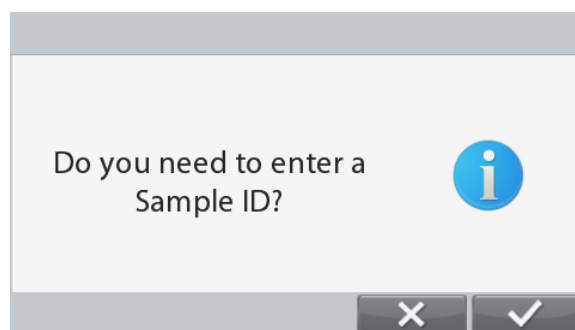

Weigh, or input manually, the original sample as Start Weight if needed.

**Note:** This screen will not show if Start Weight is chosen for calculation in **Configuration**.

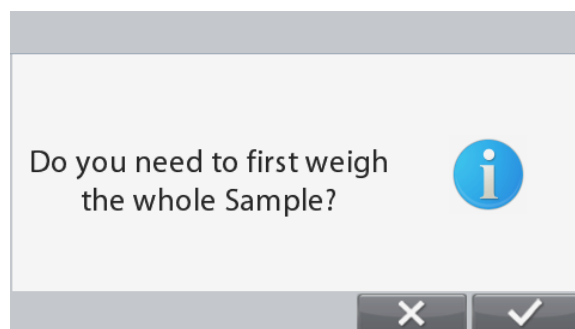

Add Start Weight and press the button corresponding to the  icon.



Alternatively, press the button corresponding to the  icon.

A numeric input screen appears.

Key in the Start Weight using the alphanumeric keypad, then press the button corresponding to the  icon.

Remove the original weight for processing or shaking.



After processing or shaking is completed, press the button corresponding to the  icon to begin Sieve analysis.



Place container on pan. The scale will then perform an auto tare.



**Note:** Press the button corresponding to the  icon to cancel current process if needed.

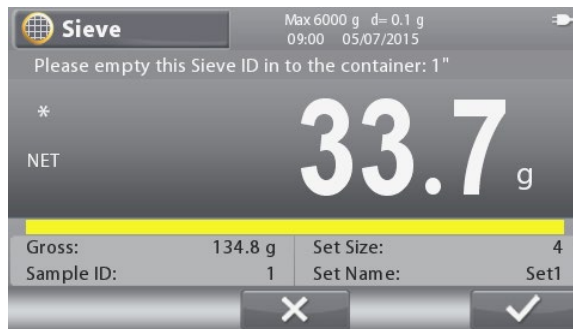

Empty sieve contents in to the container and press the button corresponding to the  icon.



After all sieves have been weighed, the result screen will be displayed.

To print the Sieve Result, press the button corresponding to the icon  or the button .

To return to the main screen, press the button corresponding to the icon .

Sieve Result				
Item	Sieve	retained	% retained	% passed
04	1"	33.7 g	20.01%	79.99%
03	#4	71.6 g	42.52%	37.47%
02	4mm	21.1 g	12.53%	24.94%
01	Pan	42.0 g	24.94%	0.00%



### 4.11 Library

When an item is processed on a regular basis, the item's data may be stored in memory for future use. This memory is referred to as the Scale's Library.

The following data is stored for the Application used:

Application	PN (Part Number)	Name	Preset Tare	APW	Ref./Target Weight	Expiration Date	Remark	Check Limits	SP (Set Points)	Sieve Size Calculate FM	Max Records	Platform	
Weighing	x	x	x			x	x				2000		
Counting	x	x	x	x		x	x				2000		
Percent			N/A									x	
Check	x	x	x	x		x	x	x			2000		
Dynamic			N/A									x	
Filling	x	x	x	x	x	x	x		x		2000		
Formulation	x	x	x		x	x	x				50	x	
Differential			N/A									x	
Density			N/A									x	
Sieve		x								x	30		

**Notes:** Maximum length of PN and Name is 30 characters.  
 For the Formulation library, each record can store up to 30 components.  
 For the Sieve library, each record can store up to 10 sizes.

#### 4.11.1 Creating a Library Record

To create a Library record, press the Library button . The requested data records will appear according to the active application mode (see section 4.10 above). In this example the Weighing Library screen is now displayed.

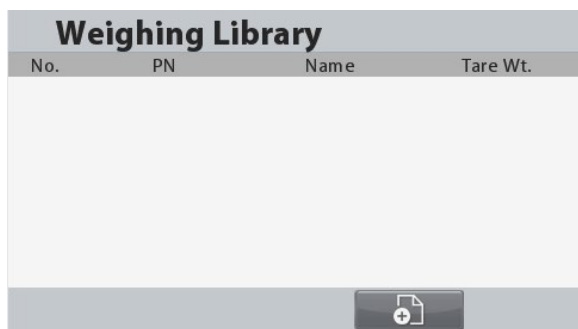



To return to the previous screen press the Library button  again.

To add a Library record, press the button corresponding to the icon .

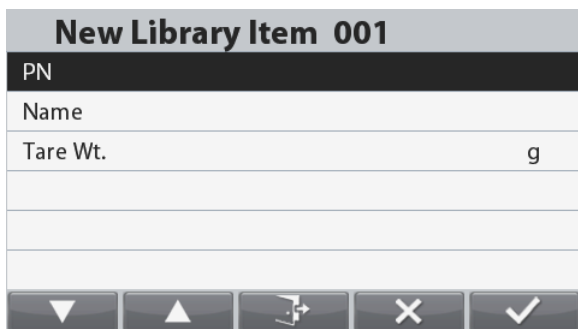
The New Library Item screen is displayed



Press the button corresponding to the icon  to enter PN by using the alphanumeric keypad.

Press the button corresponding to the icon  again to save the Barcode.

Repeat the process to enter Name, Tare Weight and other values by using the button corresponding to  to move down in the list.

Press the button corresponding to the  icon to go back to Library List screen.

Edit Sieve	
Unit	mm
Value	
Calculate FM	Off
Display Value	Pan
Value(mm)	0.000 mm

Sieve Weighing: Sieves in a set can be entered as a mix of inch, # and mm or cm sizes, but the Ranger 7000 uses mm measurements for all of its calculations.

Each individual Sieve can be edited so that the following information is associated with the Sieve:

Unit – the Sieve gradiation in inches, #, cm or mm

Value – the numeric value for the unit (ex.: a "3" for a 3 inch sieve).

Calculate FM – will the individual Sieve be used to calculate the Modulus of Fineness?

Display Value – how the individual Sieve will be shown on the Sieve Set summary in the Library.

Value(mm) – The conversion of the Value and Unit for the Sieve into mm.

Once all Sieves in at least one Sieve Set has been added to the Library under Sieve Weighing, the Sieve Weighing Mode can be used.

4.11.2 Retrieving a Library Record

To load a Library record from the home screen

press the button.

The Weighing Library screen is now displayed.

Use numeric keyboard to search the library. For example, key in 111 will lead you to the library ID:111 (If existed).

Then press the button corresponding to the icon to load the Library data and return to the Application mode related to the Library record.

Weighing Library			
ID	PN	Name	Tare Wt.
0001	22	266	

**Note:** The retrieving method can be configured in Main Menu > Setup > Barcode Confirm

- On: Click on the "Recall" button or scan the barcode twice to retrieve the record
- Off = The record will be retrieved directly when the barcode is scanned.

For details, refer 5.4.9 **Barcode Confirm**

4.11.3 Editing a Stored Library Record

To delete a stored record, follow "Retrieving a Library Record" above.

Use the buttons corresponding to the icons and to move up and down in the list and highlight the Library item to be edited.

Then press the button corresponding to the icon .



The Edit Library Item screen will be displayed. Make the necessary changes and the press the button corresponding to the icon to return to the Library List.

New Library Item 0001	
PN	22
Name	266
Tare Wt.	g

## 4.11.4 Deleting a Stored Library Record

To delete a stored record, follow “Editing a Stored Library Record” above.

Press the button corresponding to the icon . A new screen will be displayed asking for confirmation.

Press the button corresponding to the icon  to delete the record, or press the button corresponding to the icon  to go back to the previous screen.

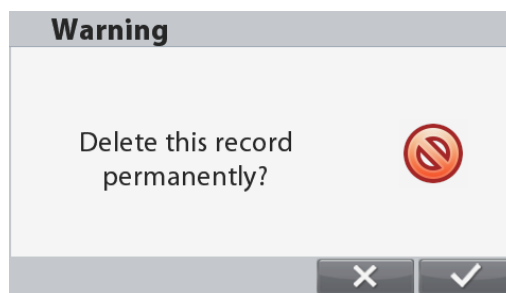

## 4.12 Additional Features

## 4.12.1 Weigh Below

The Ranger 7000 Scale is equipped with a weigh below hook for weighing below the scale.



**CAUTION:** Make sure that the scale is properly supported so that it cannot fall or detach during use of the Weigh below feature. Failure to follow these instructions could result in personal injury and damage to the equipment.

To use this feature, remove power from the scale, then remove the protective cover for the weigh below opening (2 screws). The protective cover is reversible for easy storage.



With Cover

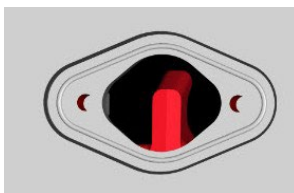

Without Cover

The scale can be supported using lab jacks or any other convenient method. Ensure the scale is level and secure. Power on the Scale, then use an appropriate string or wire to attach items to be weighed.

## 5. MENU SETTINGS

### 5.1 Menu Navigation

To enter the Main Menu, press the  button from any Application Home screen.

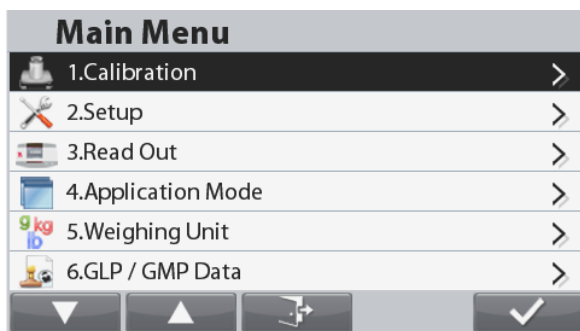

#### Changing Settings

To change a menu setting, navigate to that setting using the following steps:

##### Enter the Menu

From any Application screen, press the  button.

The Main Menu List appears on the display.

##### Select the Sub-Menu

Scroll to the desired Sub-menu in the Main Menu List by using the button corresponding to the icon



. Press the button corresponding to the

icon  to display the Sub-menu items.



Alternatively, you can select each item through pressing the number on keyboard which is corresponding to the number before each item.

For example, press 1 on keyboard to select Reset.

##### Select the Sub-Menu Item

Scroll to the desired Sub-menu Item using the button corresponding to the icon .

Press the button corresponding to the icon  to view the Sub-menu item's settings.



Select the Setting.

Scroll to the desired Setting using the button corresponding to the icon .

Press the button corresponding to the icon  to select the setting.

Alternatively, you can select each item and setting through pressing the number on keyboard which is corresponding to the number before them.

Press the  button to return to the previous screen.

Press the  button or the button corresponding to the icon , to exit the menu mode and return to the last active Application mode.

### 5.2 Main Menu

The Main menu selections are illustrated below.

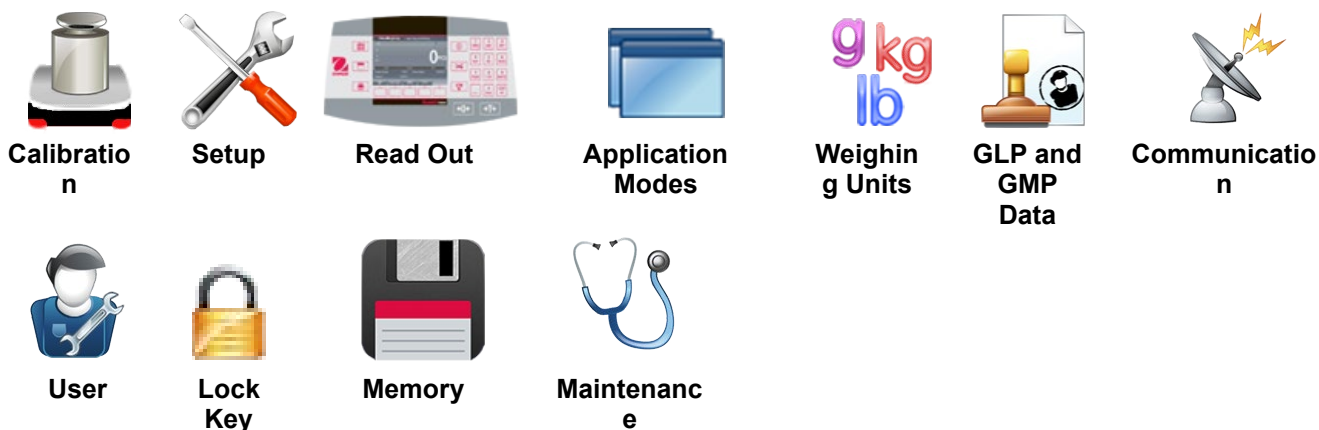

### 5.3 Calibration

R71MD models offer three calibration methods: Zero Calibration, Span Calibration and Linearity Calibration.

R71MHD models offer 5 calibration methods: Zero Calibration, Span Calibration, Linearity Calibration, Internal Calibration and Automatic Calibration.

Do not disturb the scale during any calibration.

#### 5.3.1 Calibration sub-menu

R71MD models:

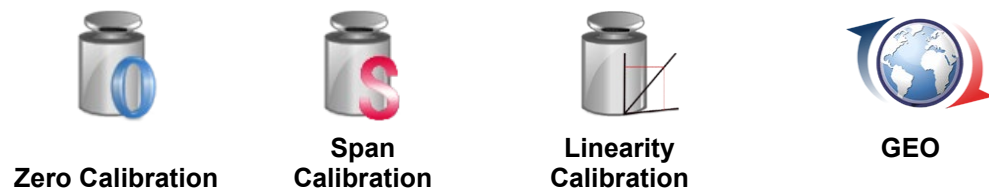

R71MHD models:

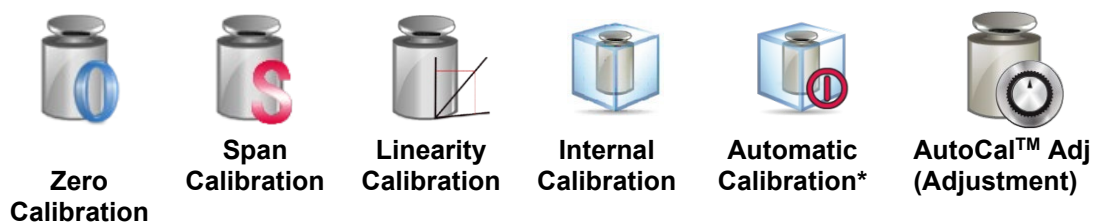

### 5.3.2 Zero Calibration

Use this calibration method to adjust the zero calibration point, without affecting the span or linearity calibration.

**Note:** Zero Calibration is only available on 2<sup>nd</sup> platform.

### 5.3.3 Span Calibration

Span calibration uses two calibration points, one at zero load and the other can be chosen by the user by using the numerical keypad.

With the scale turned ON and no load on the pan, start Span Calibration to initiate the procedure. Additional calibration values to be used are shown on the display. The best accuracy is achieved using the mass closest to the full span value.

### 5.3.4 Linearity Calibration

Linearity calibration uses three calibration points, one at zero load and the others at specified loads. Refer to Table 5.1 for Linearity values.

**TABLE 5-1 Calibration Masses**

Model	Linearity Calibration Points	Weight Class	
		ASTM Class	OIML Class
R71MHD3	0 kg, 1.5 kg, 3 kg	ASTM Class 2	OIML F1
R71MHD6	0 kg, 3 kg, 6 kg	ASTM Class 2	OIML F1
R71MHD15	0 kg, 10 kg, 15 kg	ASTM Class 2	OIML F1
R71MHD35	0 kg, 20 kg, 35 kg	ASTM Class 2	OIML F1
R71MD3	0 kg, 1.5 kg, 3 kg	ASTM Class 5	OIML M1
R71MD6	0 kg, 3 kg, 6 kg	ASTM Class 5	OIML M1
R71MD15	0 kg, 10 kg, 15 kg	ASTM Class 5	OIML M1
R71MD35	0 kg, 20 kg, 35 kg	ASTM Class 5	OIML M1
R71MD60	0 kg, 30 kg, 60 kg	ASTM Class 5	OIML M1

### 5.3.5 Internal Calibration (R71MHD models)

Calibration is accomplished with the internal calibration mass. Internal calibration can be performed at any time, provided the scale has warmed up to operating temperature and is level.

With the Scale turned ON and no load on the pan, select Internal Calibration.  
The Scale begins to calibrate.

The display shows the status, then returns to the current application.

To cancel at any time, press .

### 5.3.6 Automatic Calibration (R71MHD models)

When **Automatic Calibration** is set ON, the scale performs a self-calibration:

- when it senses a temperature change of 1.5°C
- or every 11 hours

AutoCal will automatically calibrate the Scale (using the internal mass) each time there is a change in temperature significant enough to affect accuracy.

**Note:** \* Automatic Calibration function is only available in certain regions.

### 5.3.7 AutoCal™ Adj (Adjustment)

Use this calibration method to adjust the span calibration point, without affecting the span or linearity calibration. Calibration Adjust may be used to adjust the result of the Internal Calibration by +100 divisions.

**Note:** Before making a calibration adjustment, perform an Internal Calibration. To verify whether an adjustment is needed, place a test mass equal to the span calibration value on the pan and note the difference (in divisions) between the nominal mass value and the actual Balance reading. If the difference is within +1 division, calibration adjustment is not required. If the difference exceeds +1 division, calibration adjustment is recommended.

Example:

Actual weight reading:	200.014
Expected weight reading:	200.000 (Test mass value)
Difference Weight (d):	0.014
Difference weight in digits:	-14 (Adjust value)

To perform a Calibration Adjustment, touch AutoCal Adjustment from the Calibration Menu; Enter the value (positive or negative divisions) to match the difference noted earlier in the procedure. Recalibrate using Internal Calibration. After calibration, place the test mass on the pan and verify that the mass value now matches the displayed value. If not, repeat the procedure until Internal Calibration reading agrees with the test mass.

Once completed, the balance stores the Adjustment value and the display returns to the current application.

**5.3.8 GEO Adjustment**

Enter this sub-menu to set the GEO values.

Press the button corresponding to the icon  to adjust the GEO value.

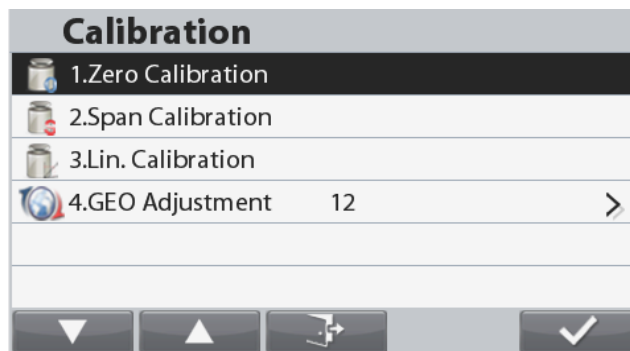

Choose the correct GEO value and press the button corresponding to the icon  to confirm.

The values range from 0-31.



**Note:** GEO is only available in R71MD models. See table 9-3 for GEO values.

**5.4 Setup**

Enter this sub-menu to customize Scale display functionality.



**5.4.1 Scale Setup sub-menu**



Factory default settings are shown below in bold.



**5.4.2 Reset**  
Reset all settings to factory default settings.

 = Reset.  
 = Do not reset and return to Setup menu screen.



**5.4.3 Language**  
Set the language displayed for menus and displayed messages.

- English**
- Spanish
- German
- French
- Italian
- Chinese

Korean  
Polish  
Portuguese  
Japanese



**5.4.4 Power On Unit**  
Set the unit that will be displayed at Power On.

**Auto**  
Kilogram  
Pound  
Gram  
Ounce  
Pound:Ounce  
Custom Unit



**5.4.5 Power On Zero**  
Zero the balance at Power On.

OFF = disabled.  
**ON** = enabled.



**5.4.6 Key Beep**  
Set whether or not the beeper sounds when a button is pressed.

OFF = disabled.  
**ON** = enabled.



**5.4.7 Expand Display**  
Set the expand display resolution. When set to x10, the display resolution will be enlarged 10 times.

OFF  
**x10**  
x20

Example:

For the 35kg x 5g model:

When set to x10, the display resolution will be 35kg x 0.5g.

When set to x20, the display resolution will be 35kg x 0.2g.

**Notes:**

x20 is not available in high resolution models.

When the scale is used in Legal for Trade the setting will be forced to OFF and it will not be changeable.



**5.4.8 Barcode Rule**  
The barcode rule validates a scanned barcode number. Two different rules can be set. If both rules are enabled, any barcode that match either rule 1 or rule 2 will be accepted by the scale.

Match Rule 1  
**OFF** = disabled.  
ON = enabled.

Match Rule 2  
**OFF** = disabled.  
ON = enabled.



Example 1:

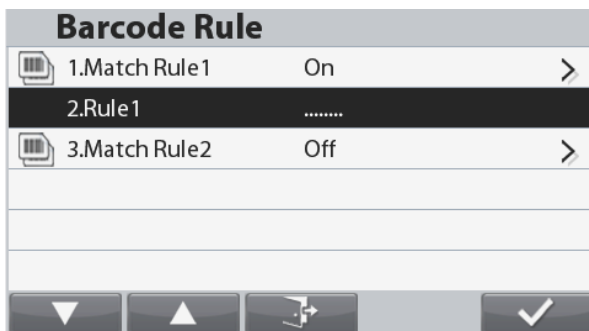

In this example the barcode rule is set to ‘.....’. This means that any barcode that is 8 characters long will be accepted by the scale, regardless of what the individual characters are.

Example 2:

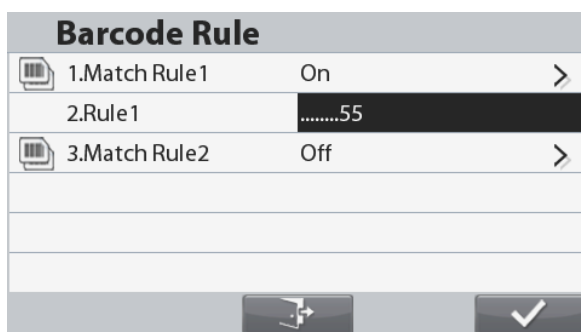

In this example the barcode rule is set to ‘.....55’. This means that any barcode that is 7 characters long and ending with the numbers ‘55’ will be accepted by the scale.

**Note:** The barcode rule is only functional when connecting a barcode scanner through the USB host.

Since there are many brands of Barcode scanners in the market, OHAUS tested and confirmed that below Barcode scanners from Datalogic are compatible with Ranger7000:

- Heron series
- QuickScan series
- Gryphon 4100 series
- Gryphon 4400 series

**5.4.9 Barcode Confirm**

Set the confirmation method of a Library record called out by barcode scanning.



**On** = Click on the “Recall” tab , or Scan the barcode twice to retrieve the record

**Off** = The record will be retrieved directly when the barcode is scanned.



**5.4.10 I/O Type**

Set the relay output parameters.

- Open = the relay output is normally open.
- Closed = the relay output is normally closed.

## 5.5 Read Out

Enter this sub-menu to customize Scale display functionality.

### Scale Read Out sub-menu



**Reset**



**Stability**



**Zero Range**



**Filter Level**



**Auto Zero Tracking**



**Brightness**



**Auto Dim (minutes)**



**Auto Sleep (minutes)**

Factory default settings are shown below in bold.



#### 5.5.1

#### **Reset**

Reset all settings to factory default settings.

Yes = Reset.

No = Do not reset and return to Read Out menu screen.



#### 5.5.2

#### **Stability**

Set the amount the reading can vary while the stability symbol remains on.

0.5 Division = 0.5 graduations

**1 Division** = 1 graduation

2 Division = 2 graduations

5 Division = 5 graduations

**Note:** The setting is forced and locked to 1 Division when the Security Switch is set to the locked position.



#### 5.5.3

#### **Zero Range**

Set the percentage of scale capacity that may be zeroed.

2%

**10%**

**Note:** The setting is forced and locked to 2% when the Security Switch is set to the locked position.



#### 5.5.4

#### **Filter level**

Set the amount of signal filtering.

LOW = faster stabilization time with less stability.

**MEDIUM** = normal stabilization time with normal stability.

HIGH = slower stabilization time with more stability.

**Note:** The setting is at the current setting when the Security Switch is set to the locked position.



#### 5.5.5

#### **Auto Zero Tracking**

Set the automatic zero tracking functionality.

OFF = disabled.

**0.5 Division** = display maintains zero up to a drift of 0.5 graduation per second

1 Division = display maintains zero up to a drift of 1 graduation per second.

3 Division = display maintains zero up to a drift of 3 graduations per second.

**Note:** The setting is forced and locked to 0.5 Division when the Security Switch is set to the locked position.



**5.5.6 Brightness**  
Set the display brightness using the numerical keypad.

20...**80**...100



**5.5.7 Auto Dim (minutes)**  
Set whether the display dims after x seconds/minutes.

**OFF** = disabled.  
1...30 (minutes)



**5.5.8 Auto Sleep (minutes)**  
Set whether the display enters sleep mode after x seconds/minutes.

**OFF** = disabled.  
1...100 (minutes)



**5.5.9 Window On Top**  
Set the information to be displayed on top.

Capacity&Graduation = Display **Capacity & Graduation** only

Date and Time = Display **Capacity & Graduation + Date & Time**

User Name = Display **Capacity & Graduation + User Name**

**Note:** Only two information can be displayed on top.



## 5.6 Application Mode

Enter this sub-menu to enable or disable the desired Scale Applications. Only one application can be running at a time.

**Note:** The use of each Application is described in detail in Section 4.

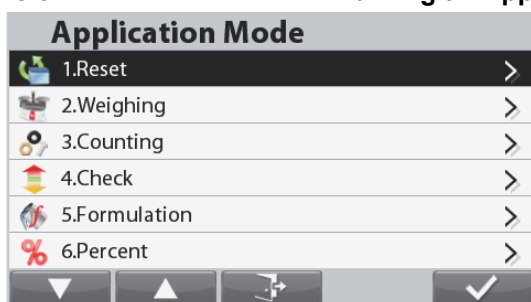
### 5.6.1 Turning an Application ON/OFF



Highlight the application by pressing the buttons corresponding to the icons   and then press the button corresponding to the icon  to enter the selected submenu.

In the Item option screen, enter the **Enabled** menu to turn it on or off.

Once an Application is enabled (turned on) it may be chosen by pressing the **Applications** button until it's icon appears in the upper left corner of the home screen. The current menu item status is shown: **OFF** = disabled, **ON** = enabled

## 5.7 Weighing Units

Enter this sub-menu to activate the desired units of measure.

**Note:** Due to national laws, the scale may not include some of the units of measure listed.

5.7.1 Units Sub-menu



**Note:** The setting is locked when the Security Switch is set to the locked position.

**Custom Unit**

Use the Custom Unit to display weight in an alternative unit of measure. The custom unit is defined using a conversion factor, where the conversion factor is the number of custom units per gram expressed in scientific notation (Factor x 10<sup>Exponent</sup>).

**Factor**

Set the conversion factor using the numeric keypad.

Settings of 0.1000000 to 1.9999999 are available. The default setting is 1.0000000.

**Exponent**

Set the factor multiplier.

- 3 = divide the Factor by 1000 (1x10<sup>-3</sup>)
- 2 = divide the Factor by 100 (1x10<sup>-2</sup>)
- 1 = divide the Factor by 10 (1x10<sup>-1</sup>)
- 0 = multiply the Factor by 1 (1x10<sup>0</sup>)
- 1 = multiply the Factor by 10 (1x10<sup>1</sup>)
- 2 = multiply the Factor by 100 (1x10<sup>2</sup>)

**Least Significant Digit**

Set the graduation.

Settings of 0.5, 1, 2, 5, 10, 100 are available.

The Custom Unit's name can be customized up to 3 characters.

**Note:** Custom Unit is locked at Off position when the Security Switch is set to the locked position.

5.7.2 **Reset**



To reset the unit settings to factory default settings select Reset and then confirm either Yes or No.

5.7.3 **Turning a Unit ON/OFF**

Select the desired unit, then press the button corresponding to the icon  and then choose either On or Off.

The current menu item status is shown.

- OFF = disabled
- ON = enabled

Weighing Unit		
	1.Reset	>
	2.kilogram	On >
	3.pound	On >
	4.gram	On >
	5.ounce	On >
	6.lb:oz	On >
		

5.8 **GLP and GMP Data**

Enter this menu to set the Good Laboratory Practices (GLP) and Good Manufacturing Practice data.



**GLP Data Sub-menu**

**5.8.1 Reset**  
Resets the settings to factory default settings. Reset the settings to factory default settings.



**5.8.2 Date Format**  
Set the scale date format.

MMDDYYYY = Month Day Year (default)  
DDMMYYYY = Day Month Year  
YYYYMMDD = Year Month Day



**5.8.3 Date**  
Set the current date using the alphanumeric keypad.



**5.8.4 Time Format**  
Set the scale time format.  
24H = 24 hour format (default)  
12H = 12 hour format



**5.8.5 Time**  
Set the current time.



**5.8.6 Project ID**  
Set the project ID by using the alphanumeric keypad.



**5.8.7 Scale ID**  
Set the scale ID by using the alphanumeric keypad.

**5.9 Communication**

Enter this menu to define external communication methods and to set printing parameters. Data may be output to either a printer or PC (see section 6.5 for output string). Factory default settings are shown in bold.

**Communication Sub-menu****RS232****USB**

Choosing an item brings up another menu level (RS232 shown):

**Configuration****Print Setup**

Choosing an item brings up yet another menu level, the device settings are dependent on the COM chosen (RS232 shown).

**Configuration Menu: (RS232 shown)**

**5.9.1 Reset**  
Resets the settings to factory default settings. Reset the settings to factory default settings.



### 5.9.2 Baud Rate

Set the baud rate (bits per second).

300  
600  
1200  
2400  
4800  
**9600**  
19200



### 5.9.3 Parity

Set the data bits and parity.

7 EVEN = 7 data bits, even parity  
7 ODD = 7 data bits, odd parity  
7 NONE = 7 data bits, no parity  
**8 NONE = 8 data bits, no parity**



### 5.9.4 Stop Bits

Set the stop bits.

**1 BIT**  
2 BIT



### 5.9.5 Handshake

Set the flow control method.

**NONE = no handshaking**  
XON/XOFF = XON/XOFF handshaking  
HARDWARE = hardware handshaking (COM1 menu only)



### 5.9.6 Alternate Command

Enter this sub-menu to set a different command character for the P (Print), T(Tare) or Z(Zero)



### 5.9.7 Reference Balance

**Off = do not connect to reference balance**

On = connect to reference balance

**Note:** Use reference balance to perform sampling with high resolution balance in Counting Mode.

Please make sure the balance is already switched on before connecting to Ranger 7000.

### Alternate Print Command

Set the alternate command character for Print.

Settings of A(a) to Z(z) are available, except T&Z. The default setting is **P**.

### Alternate Tare Command

Set the alternate command character for Tare.

Settings of A(a) to Z(z) are available, except P&Z. The default setting is **T**.

### Alternate Zero Command

Set the alternate command character for Zero.

Settings of A(a) to Z(z) are available, except P&T. The default setting is **Z**.

### Print Setup Menu: (RS232 shown)



### 5.9.8 Reset

Resets the settings to factory default settings. Reset the settings to factory default settings.



### 5.9.9 Stable Weight Only

Set the printing criteria.

**OFF** = values are printed immediately, regardless of stability.  
**ON** = values are printed only when the stability criteria are met.



**5.9.10 SICS**  
**Off** = disable MT-SICS command  
**On** = enable MT-SICS command



**5.9.11 Print Options**  
 Set the printing criteria.  
**PC** = Print data to a PC  
**SF40A** = Print data to printer SF40A  
**ZEBRA** = Print data to printer ZEBRA



**5.9.12 Auto Print**  
 Set the automatic printing functionality.  
**Auto Print Mode**  
**OFF** = disabled  
**ON STABLE** = printing occurs each time the stability criteria are met.  
**INTERVAL** = printing occurs at the defined time interval.  
**ACCEPT** = printing occurs each time the display is within the Checkweigh accept range and stability criteria are met.  
**CONTINUOUS** = printing occurs continuously.

When ON STABLE is selected, set the time interval using the numeric keypad.

**LOAD** = prints when the displayed load is stable

**LOAD ZERO** = prints when the displayed load or zero reading is stable.

When INTERVAL is selected, set the time interval using the numeric keypad.

Settings of **1** to 50000 seconds are available.

**Note:** Pressing the print button when INTERVAL has been selected will print the displayed result immediately.

**Continuous**

**OHAUS** = Compatibility with OHAUS products that require real-time weight data  
**MT Standard** = Compatibility with METTLER TOLEDO products that require real-time weight data

**Checksum**

**Off = disabled**  
**On = enabled**

**MT Standard Continuous Output**

A checksum character can be enabled or disabled with continuous output. The data consists of 17 or 18 bytes as shown in Table 5-1.

Non-significant weight data and tare data digits are transmitted as spaces. The continuous output mode provides compatibility with OHAUS products that require real-time weight data.

Table 5-1 shows the format for the standard continuous output.

Table 5-1: Standard Continuous Output Format

Character	Status <sup>2</sup>			Indicated Weight <sup>3</sup>						Tare Weight <sup>4</sup>								
	1	2	3	4	5	6	7	8	9	10	11	12	13	14	15	16	17	18
Data	STX <sup>1</sup>	SB-A	SB-B	SB-C	MSD	-	-	-	-	LSD	MSD	-	-	-	-	LSD	CR <sup>5</sup>	CHK <sup>6</sup>

**Continuous Output Format Notes:**

1. ASCII Start of Text character (02 hex), always transmitted.
2. Status bytes A, B and C. Refer to Table 5-2, Table 5-3, and Table 5-4 for details of the structure.
3. Displayed weight. Either gross or net weight. Six digits, no decimal point or sign. Insignificant leading zeroes are replaced with spaces.
4. Tare weight. Six digits of tare weight data. No decimal point in field.
5. ASCII Carriage Return <CR> character (0D hex).
6. Checksum, transmitted only if enabled in setup. Checksum is used to detect errors in the transmission of data. Checksum is defined as the 2's complement of the seven low order bits of the binary sum of all characters preceding the checksum character, including the <STX> and <CR> characters.

Table 5-2, Table 5-3, and Table 5-4 detail the status bytes for standard continuous output.

**Table 5-2: Status Byte A Bit Definitions**

Bits 2, 1, and 0			
2	1	0	Decimal Point Location
0	0	0	XXXXX00
0	0	1	XXXXX0
0	1	0	XXXXXX
0	1	1	XXXXX.X
1	0	0	XXXX.XX
1	0	1	XXX.XXX
1	1	0	XX.XXXX
1	1	1	X.XXXXX
Bits 4 and 3			
4		3	Build Code
0		1	X1
1		0	X2
1		1	X5
Bit 5			Always = 1
Bit 6			Always = 0

**Table 5-3: Status Byte B Bit Definitions**

Status Bits	Function
<b>Bit 0</b>	Gross = 0, Net = 1
<b>Bit 1</b>	Sign, Positive = 0, Negative = 1
<b>Bit 2</b>	Out of Range = 1 (Over capacity or Under Zero)
<b>Bit 3</b>	Motion = 1, Stable = 0
<b>Bit 4</b>	lb = 0, kg = 1 (see also Status Byte C, bits 0, 1, 2)
<b>Bit 5</b>	Always = 1
<b>Bit 6</b>	Zero Not Captured after power-up = 1

**Table 5-4: Status Byte C Bit Definitions**

Bits 2, 1, and 0			Weight Description
2	1	0	
0	0	0	lb or kg, selected by Status Byte B, bit 4
0	0	1	grams (g)
0	1	0	metric tons (t)
0	1	1	ounces (oz)
1	0	0	not used
1	0	1	not used
1	1	1	tons (ton)
1	1	1	no units
Bit 3			Print Request = 1
Bit 4			Expand Data x 10 = 1, Normal = 0
Bit 5			Always = 1
Bit 6			Always = 0



**5.9.13 Print Cal Data**

Set the automatic Calibration Data printing functionality.

- Off = disabled
- On = enabled

**Note:** Once enabled, calibration data will be printed automatically when you start calibration.



**5.9.14 Select Template**

This sub-menu is used to define the format of the data output to a printer or computer.

- Simple** = only prints result and unit
- Custom 1 = customized printout format. If not customized, Simple template will be used
- Custom 2 = customized printout format. If not customized, Simple template will be used
- Custom 3 = customized printout format. If not customized, Simple template will be used



Custom 4 = customized printout format. If not customized, Simple template will be used  
 ZEBRA = Preset template

Example (Simple Template):

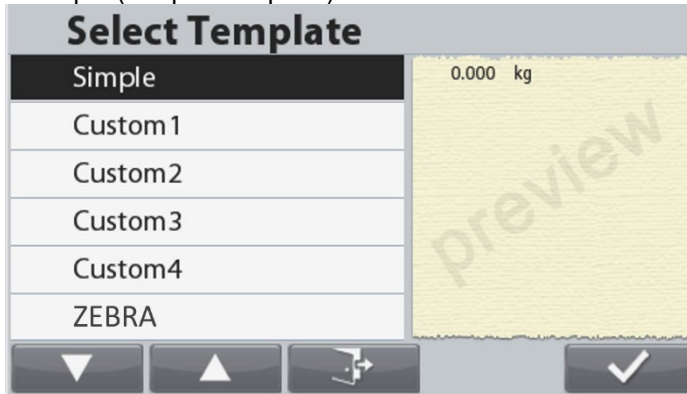

**5.9.15 Edit Template**

This sub-menu is used to edit the current Print template. Each template supports up to 50 data fields to define the format of the data output.

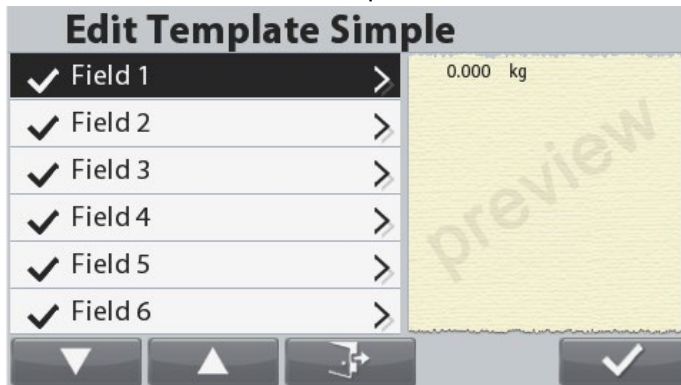

To format a template, first select the field number (from 1 to 50). A content window is displayed for the selected field.

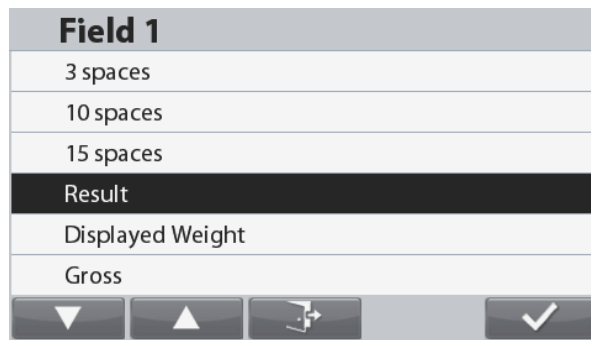

Item	Length	Item	Length
3 spaces	3	Batch Number	
10 spaces	10	Remark	40
15 spaces	15	String 1	Up to 40
Date	10	String 2	Up to 40
Displayed Weight	23	String 3	Up to 40
Displayed Number	13	String 4	Up to 40
End of Template	0	String 5	Up to 40
Print Expi Date	40	String 6	Up to 40
Gross	23	String 7	Up to 40

User ID	Up to 12
Net	23
New Line (<CR><LF>)	2
Information	No fixed length
Project ID	Up to 40
Serial Number	10
Scale ID	Up to 40
Result	23 or 29 (Check mode)
Mode	Up to 14
PN	Up to 30
ID	
Work Order Number	

String 8	Up to 40
String 9	Up to 40
String 10	Up to 40
Tare	23
Time	5 or 8 (12 hour format)
Alibi ID	6
Accumulation	No fixed length
Library ID	4
Library Name	Up to 30
Input status	2(00)
Output status	4(1111)

See section 6.6 for sample printouts.

**Terminating a template**

To terminate a template, an End of Template field must be included. All fields after the End of Template field will be ignored. If a field is chosen as End of Template, the ✓ will be removed from this field as shown below.

Field 2	Edit Template Simple
Displayed Weight	✓ Field 1 > 0.000 kg
Gross	Field 2 >
Net	Field 3 >
Tare	Field 4 >
New Line	Field 5 >
End of Template	Field 6 >

Navigation icons: Down arrow, Up arrow, Left arrow, Right arrow, Checkmark.



**5.9.16**

**Edit String**

Up to 10 Strings can be edited using the alphanumeric keypad.



**5.9.17 Data Transfer**

Output weighing results directly to a PC application. Setup is easy and no additional software is required.

**Note:** Data Transfer Function is not supported in Windows® 7/8. OHAUS provides SPDC software for Windows 7/8 users.

- OFF** = do not print.
- ON** = print the specified settings.

Click the Start Menu in Windows XP system and click “Settings” →open **Control Panel**.

Double click **Accessibility Options** in Control Panel.

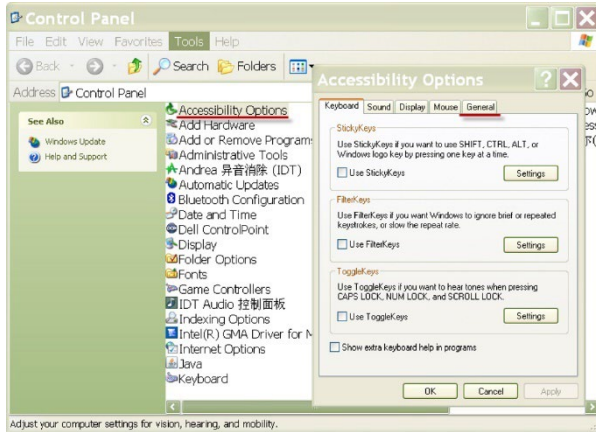

Select the **General** tab in Accessibility Options.

Check **Use Serial Keys**, and click the **Settings** button.

Select the **Serial Port**, and set the **Baud rate** to **9600**.

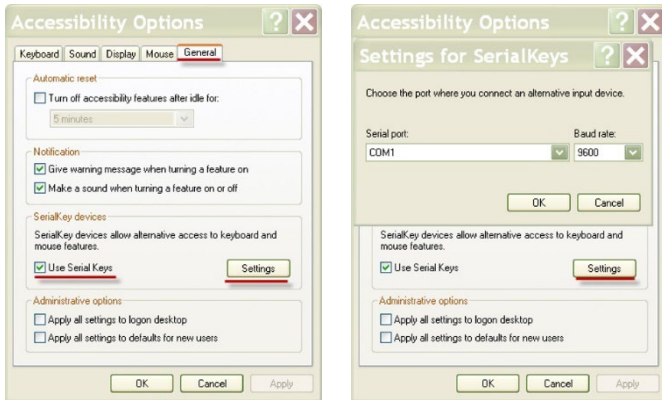

After selecting, click **OK** to close setting for serial keys. Close the Control Panel.

Run Excel® to open one blank sheet. Click on the cell where the data is to be placed. At this time, if the scale sends data to the PC through the RS232 port, the data will be put into the cell, and the cursor will automatically move to the next vertical cell.

**Note:** If the weighing value is a negative number, set the target cell in TEXT format. Otherwise, Excel will not distinguish it as a negative number.

5.10 User

Enter to view and edit user settings.

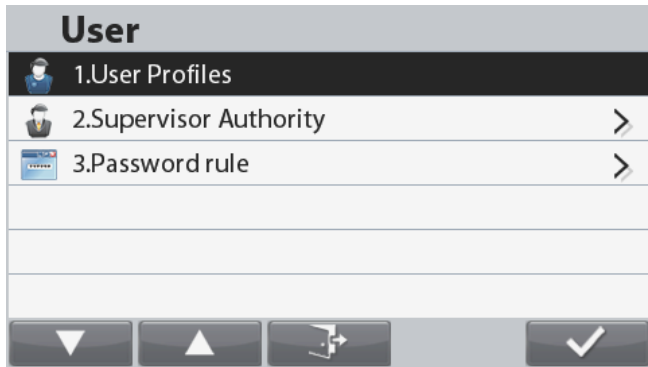

5.10.1 User Profiles

Create users with user name and password.

User Screen

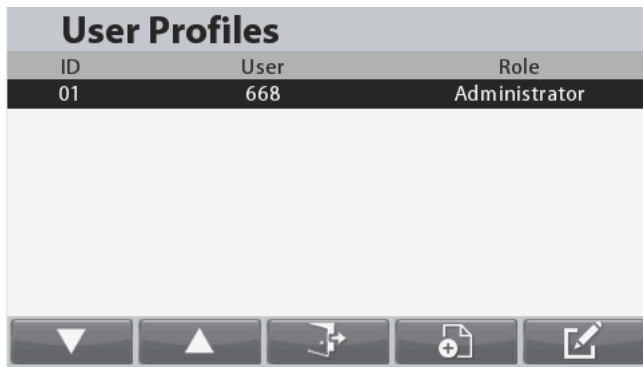

Functions

The User profile is used for saving user specific parameters in menu

Total 50 user profiles can be saved in file system

User name max length: 32

Password max length: 32

User authorities

User types

- a) Administrator
- b) Supervisor
- c) Operator
- d) Guest

**Notes:** The first user is always Administrator  
If no user have been created, login as Administrator.

The admin can add, edit and delete all users. The supervisor can add, edit and delete operators. The operator has no right to add, edit or delete any user, and this role can only recall library.

**Guest Account:**

Login as a Guest user will occur directly when pressing the button corresponding to the icon , no password is required.

The Guest user can view but cannot modify the general menu settings. All the menus are locked. The Guest user can modify the app configurations but cannot add/edit library records.

Login Screen

Long press the  button to start the User login screen to change the user. Login is also required during power up.



To login as Adminrator press the button corresponding to the icon . A login screen is displayed with a password field. Enter the password associated with the account.

If the wrong password is entered, an error screen will be displayed. Press the button correponding to the icon  to return to the login screen.

To login as guest press the button corresponding to the icon .

**Note:** if no user was created, no login is required and automatically login as administrator.  
Creating a new user

To create a new user, press the button corresponding to the icon .

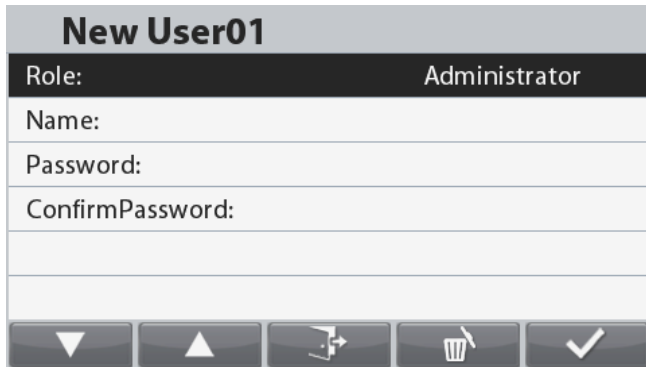

Select user role, and then enter the user name and password and press the button correponding to the icon  to return to the login screen.

Deleting a user

To delete a user, select the user to be deleted in the list and press the button corresponding to the icon .

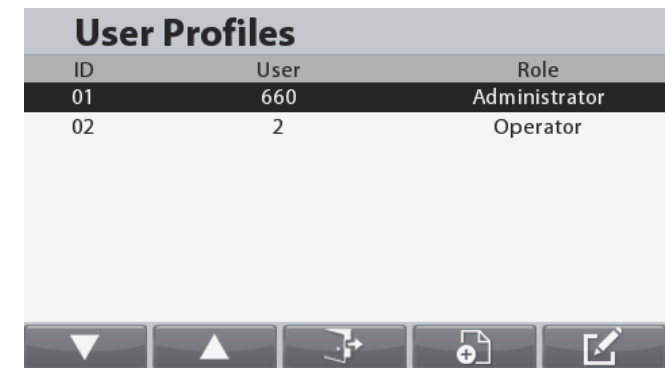

In the Edit User screen, press the button corresponding to the icon .

A confirmation window appears.

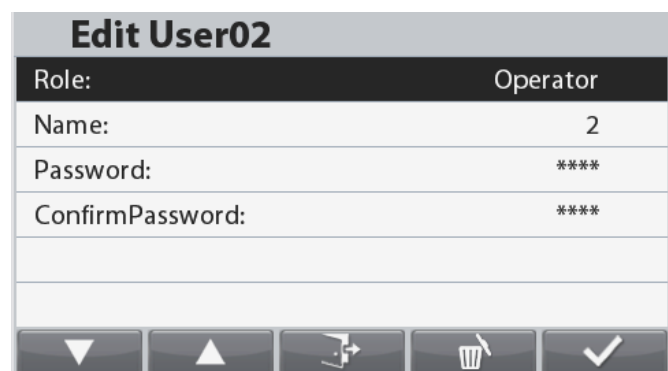
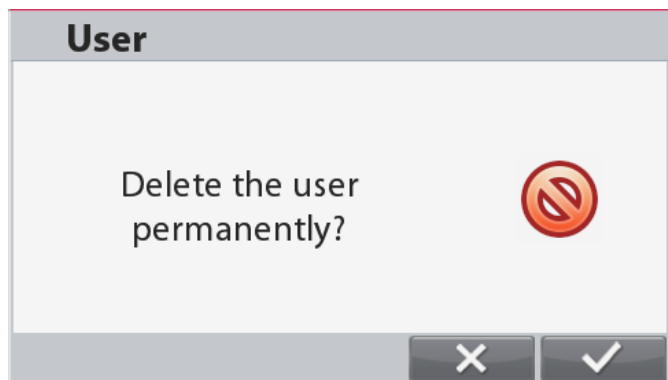

Press the button corresponding to the icon  to delete the user permanently or  to cancel the deletion and return to User Profiles main screen.

**5.10.2 Supervisor Authority**

The admin user can set the authority of the supervisor as the following:

Item	Available Settings (bold is the default settings)
Calibration	<b>Off</b> , On
Date/Time	<b>Off</b> , On
Setup	<b>Off</b> , On
Communication	<b>Off</b> , On
Memory	<b>Off</b> , On
Library	<b>Off</b> , On
Maintenance	<b>Off</b> , On

**5.10.3 Password Rule**

The password has a period of validity. A password change notification will show 15 days before the password validity period. If the period of validity has expired, user must change the password immediately when login.

The length of the password must bigger than the "Min length" and smaller than 32.

There is three complexities of the password.

Complexity	Password Character
Numeric	Numeric
Alpha numeric	Numeric & letter
Match case	Numeric & lowercase letter & upper case letter

### 5.11 Lock Key

This menu is used to lock access to certain keys. When you select ON for one selection, the associated key press will be ignored.

If you select Lock All Keys, you will lose function of all keys. In this kind of situation, if you want to restore the settings, long press the  button for 10 seconds to enter the menu and re-set.

Item	Available Settings (bold is the default settings)
Reset	<b>No</b> /Yes
Lock All Keys	<b>Off</b> , On
Lock Zero Key	<b>Off</b> , On
Lock Tare key	<b>Off</b> , On
Lock Mode key	<b>Off</b> , On
Lock Print Key	<b>Off</b> , On
Lock Menu key	<b>Off</b> , On
Lock Unit Key	<b>Off</b> , On
Lock Soft Key	<b>Off</b> , On
Lock Library key	<b>Off</b> , On

## 5.12 Memory

### 5.12.1 Log Memory

Log Memory enables you to check Software Upgrade History, Indicator Info and System Log.

All the changes made on indicator setting will be recorded in a system log file (maximum 3,000 records), e.g. every printed data, date/time change, indicator setting changes, perform calibration action, user log in/log out, user account create/edit/delete and etc.

These system log files can be reviewed and exported to USB. Log records can be reviewed on ScaleMate software.

#### Enable Log Memory

Log Memory is "Off" by default. To enable Log Memory,

1. Navigate to Main Menu > Memory > Log Memory > System Log
2. Select "On".

Note: Log Memory only records data when System Log is selected "ON".

#### Export Log Records to USB

1. Connect your USB device. The  icon will appear.  
**Note:** This icon will be visible only after a USB device is connected.
2. Press  button to export the log records.

#### Clear Log Records

**Note:** Log records can be cleared only after the log is exported to USB.

After the log is exported to USB, the  icon will appear. Press the button to clear log records.

### 5.12.2 USB memory

USB memory is used to store the weight readings for future reference. In the USB memory menu, set the status to On to enable this feature.





By connecting a USB flash drive to the scale the weight readings can now be stored directly on the USB flash drive. The format of the data sent to the flash drive depends on the USB communication setup, please refer to section 5.9 for detail.

The data will be stored in the flash drive in the following location:

\\SYSTEM\\DATA

A new file will be created monthly (one txt file stores a whole month's output data...)

 201606.TXT	2016/6/28 14:26
 201607.TXT	2016/7/7 14:25



### 5.12.3 Alibi memory

**Note:** This menu is only visible if the Alibi memory hardware option has been installed. See below for installation instructions.

Alibi memory is used to store the weight history for reference. Each Alibi record contains a Record ID, Net Weight value, Tare value and Date & Time.

Enter the Check Records menu item to review the records.

**Notes:**

The maximum number of record is 262112. When the memory is full and another record is stored the first record will automatically be deleted. At this time a warning message will appear, asking for the user's confirmation.

The latest record is always displayed on top. Use the buttons corresponding to the icons and to move up and down the list.

Press the button corresponding to the icon  to locate a record by entering it's ID No.

Press the button corresponding to the icon  to print a range of records.

Press the button corresponding to the icon  to return to previous menu.

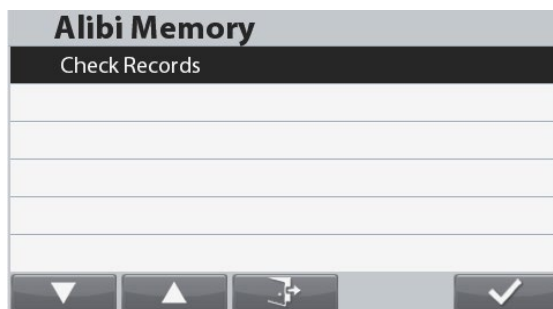

Alibi Memory Records				
No.	Weight	Tare	Date/Time	Platform
1	1.10g	0.00g	01/01/2013 00:01	1
2	50g	34,5g	01/01/2013 00:05	1

Below the table are five buttons: a downward arrow, an upward arrow, a search icon, a range icon, and a return icon.

**Note:** Only stable weight can be printed to the Alibi memory. Stable weight is stored in Alibi memory only by manually press the printing button.

## Alibi Memory Option Board Installation

### STEP 1. Opening the terminal module

#### A) Detaching the Terminal from the base.

1. Switch off and disconnect the scale from main power supply.
2. Detach the display terminal from the base by pressing both release buttons at the same time as show below picture. After that pull the Terminal towards you (outward) until the Terminal is detached from the base as show below.

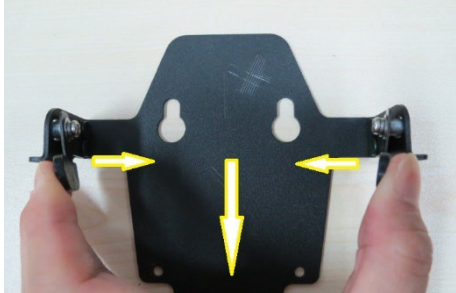

#### B) Detaching the base cable from the Terminal.

Unplug the base cable from the Terminal.

#### C) Dismantling the Terminal housing.

Flip the Terminal around. There are 4 screws located underneath the rubber covers at the 4 corners of the bottom housing. Remove these rubber covers and you will be able to locate and remove the 4 hidden screws.



After removing the screws which are securing the bottom housing with the top housing turn the terminal module over. After that carefully lift up the top housing, **DO NOT** remove the top housing completely away from the bottom housing because the Terminal keypad overlay ribbon cable and TFT display ribbon cable are still attached with the Terminal main PCBA.

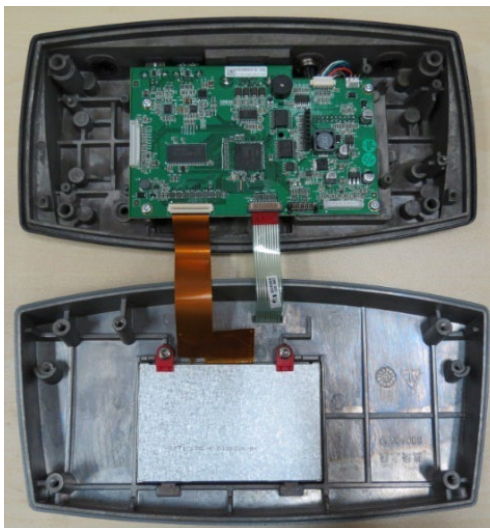

**STEP 2.** Insert the Alibi Memory board into the slot as shown below; making sure the pins and supporting plastic leg are all properly inserted.

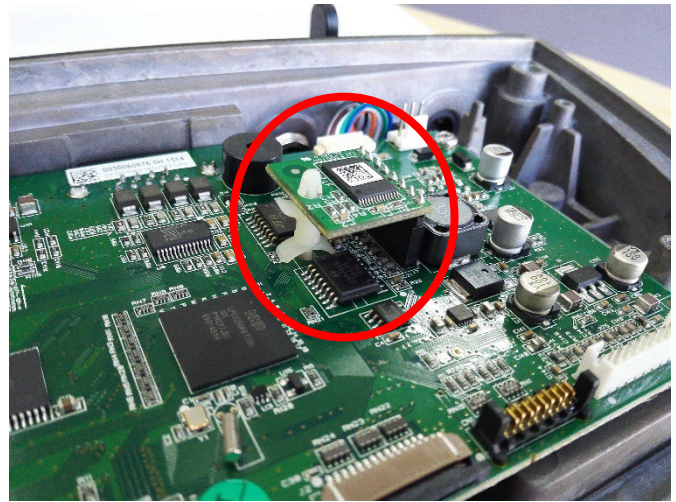
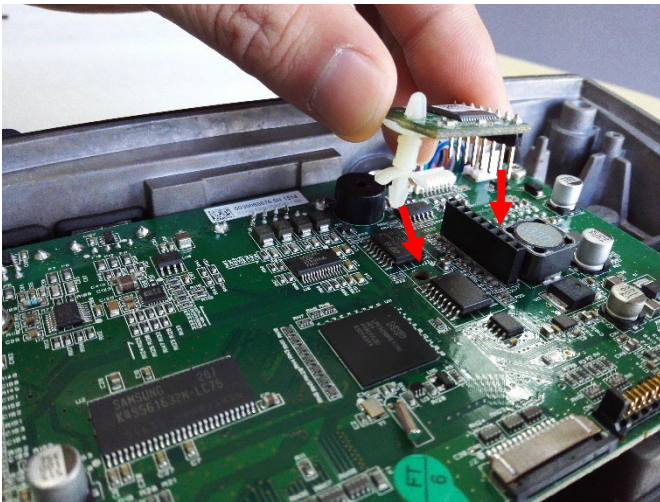
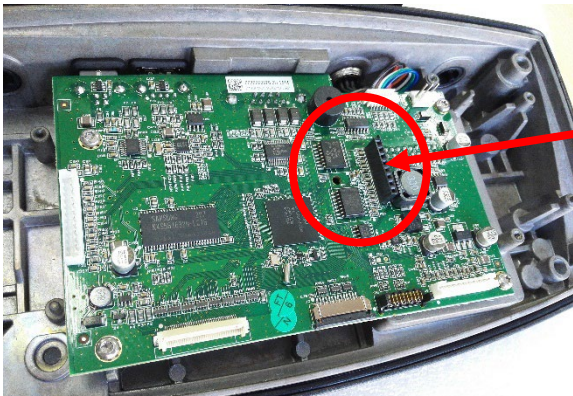

## 5.13 Maintenance



**Export  
Library**



**Export User  
Profile**



**Import  
Library  
Drives**



**Import User  
Profile**

**Note:** The import/export is only functional when the current user is administrator.

### Maintenance Sub-menu



**5.13.1** **Export Library**  
Export Library to USB flash drive.



**5.13.2** **Export User Profile**  
Export User Profile to USB flash drive.



**5.13.3** **Import' Library Drives**  
Import Library from USB flash drive.



**5.13.4** **Import User Profile**  
Import User Profile from USB flash drive.  
**Note:** The existing users will be replaced when importing users.

## 6. SERIAL COMMUNICATION

### 6.1 Interface Commands

The scale supports both MT-SICS and OHAUS commands. Commands listed in the following tables will be acknowledged by the scale. To use the MT-SICS commands, send the command PSI. To return to the OHAUS commands, send the command POH.

SICS commands can also be active in the menu setup, please refer to Section 5.9.10 for detail.

#### OHAUS Commands

Command	Function
IP	Immediate Print of displayed weight (stable or unstable).
P	Print displayed weight (stable or unstable).
CP	Continuous
SP	Print on Stability.
xS	0S: Turn off "Stable Only" menu item and allow unstable print. 1S: Turn on "Stable Only" menu item and only print stable print.
xP	Interval Print x = Print Interval (1-50000 sec), 0P turns auto print OFF
Z	Same as pressing Zero Key.
T	Same as pressing Tare Key.
xT	Download Tare value in grams (positive values only). Sending 0T clears tare (if allowed).
PU	Print current unit: g, kg, lb, oz, lb:oz
xU	Set scale to unit x: 1=kg, 2=lb, 3=g, 4=oz, 5=lb:oz
xM	Set scale to mode x. 1=Weighing, 2=Counting, 3=Check, 4=Formulation, 5=Percent, 6=Filling, 7=Dynamic, 8=Density, 9=Differential. M will scroll to next enabled mode.
PSN	Print Serial Number.
CU xxx	Set Under Limit (only in Check mode) where 'xxx' is the value under current weighing unit <ul style="list-style-type: none"> <li>In Check Weighing mode, the units are g / oz / lb, oz / kg / lb</li> <li>In Check Counting mode, the unit is pcs</li> </ul>
CO xxx	Set Over Limit (only in Check mode) where 'xxx' is the value under current weighing unit <ul style="list-style-type: none"> <li>In Check Weighing mode, the units are g / oz / lb, oz / kg / lb</li> <li>In Check Counting mode, the unit is pcs</li> </ul>
x#	Set Counting APW (x) in grams. (only in Counting or Checkcounting mode, must have APW stored)
P#	Print Counting or Checkcounting mode APW.
x%	Set Percent mode reference weight (x) in grams. (must have reference weight stored)
P%	Print Percent mode reference weight.
PV	Version: print name, software revision and LFT ON (if LFT is set ON).
H x "text"	Enter String content, x = String number (1-10), "text" = string text up to 40 alphanumeric characters.
\EscR	Global reset to reset all menu settings to the original factory defaults.
SNS x	Switch the platform: x = 1, 2
SetSP xxx xxx xxx	Set target SP1 and SP2 sequentially in current weighing unit. <ul style="list-style-type: none"> <li>In Weight Filling mode, the units are g / oz / lb, oz / kg / lb</li> <li>In Parts Filling mode, the unit is pcs</li> </ul>
DM "text"	<ul style="list-style-type: none"> <li>Enter String content, "text" = string text up to 40 alphanumeric characters. The message will be displayed on main screen.</li> </ul>
DC	Close the message
SetEpMsg1 text	To set up a service message. Enter String content, "text" = string text up to 40 alphanumeric characters.
SetEpMsg2 text	To set up a service message. Enter String content, "text" = string text up to 40 alphanumeric characters.



**MT-SICS Commands**

	Command	Function
	I0	Inquiry of all SICS commands
	I1	Inquiry of SICS level and SICS versions
	I2	Inquiry of scale data
	I3	Inquiry of scale software version
	I4	Inquiry of serial number
	S	Send stable weight value
	SI	Send weight value immediately
	SIR	Send weight value repeatedly
	Z	Zero the scale
	ZI	Zero immediately
	LEVEL 1	D
DW		Weight display
T		Tare
TA		Tare value
TAC		Clear tare
TI		Tare immediately

	Command	Function
LEVEL 2	C2	Calibrate with the external calibration weight
	C3	Calibrate with the internal calibration weight
	I10	Inquire or set scale ID
	I11	Inquire of scale type
	P100	Print out on the printer
	P101	Print out stable weight value
	P102	Print out current weight value immediately
	SIRU	Send weight value in the current unit immediately and repeat
	SIU	Send weight value in the current unit immediately
	SNR	Send stable weight value and repeat after every weight change
	SNRU	Send stable weight value in the current unit and repeat after every weight change
	SRU	Send weight value in the current unit and repeat
	SU	Send stable weight value in the current unit
	LEVEL 3	LST
M01		Weighing mode
M02		Stability setting
M03		Autozero function
M19		Send calibration weight
M21		Inquire/set weight unit
PRN		Print out at every printer interface
RST		Restart
SFIR		Send weight value immediately and repeat quickly
SIH		Send weight value immediately in high resolution
SWU		Switch weight unit
SX		Send stable data record
SXI		Send data record immediately
SXIR		Send data record immediately and repeat
U		Switch weight unit

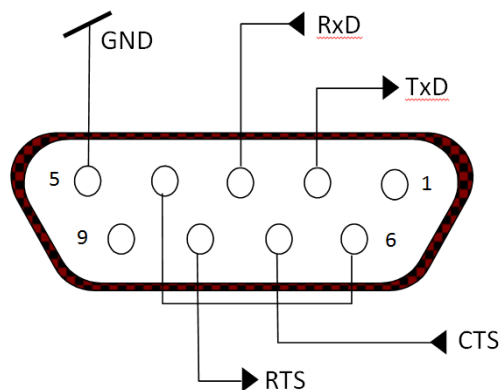

## 6.2 RS232 Interface

RS232 (DB9) Pin Connections:

Pin 2: Scale transmit line (TXD)

Pin 3: Scale receive line (RXD)

Pin 5: Ground signal (GND)

Pin 7: Clear to send (hardware handshake) (CTS)

Pin 8: Request to send (hardware handshake) (RTS)

Use the built-in RS-232 Port to connect either to a computer or a printer.

### 6.2.1 Connecting to a Computer

Connect to the computer with a standard (straight-through) serial cable.

Use HyperTerminal or a similar terminal software to test communication with the computer.

Set up HyperTerminal as follows:

Choose New Connection, "connect using" COM1 (or available COM port).

Select Baud=9600; Parity=8 None; Stop=1; Handshaking=None. Click OK.

Choose Properties/Settings, then ASCII Setup. Check boxes as illustrated: (Send line ends...; Echo typed characters...; Wrap lines...)

Verify communication by pressing the Print button. If HyperTerminal is set up properly, the value on the display will be displayed in the window.

### 6.2.2 Connecting to a Serial Printer

Connect the cable supplied with the printer to the scale's RS-232 port.

Make sure that the balance and printer communication settings match.

Test communication with the printer by pressing the Print button. If the balance and printer are set up properly, the value on the display will be printed.

### The USB Device Interface

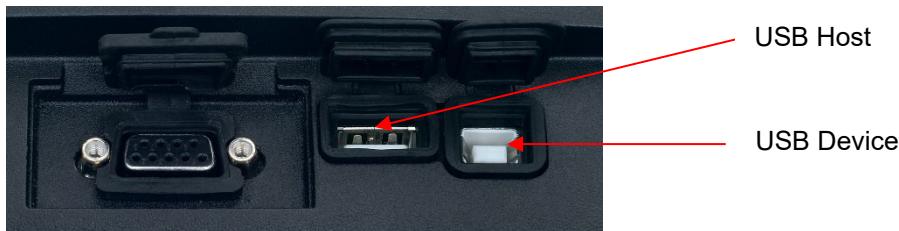

The Ohaus USB Device Interface is a unique solution to the problem of connecting a scale to a computer using a Universal Serial Bus (USB). USB devices are categorized into classes such as disk drives, digital cameras, printers, etc. Scales do not have a commonly used class so the Ohaus USB interface uses a generic interface based on the RS232 serial standard.

Data sent from the scale to a computer is in USB format. The USB data is directed to a *virtual port*. This port then appears as an RS232 port to the application program.

When sending a command from a computer to the scale, the application program sends a command to the *virtual port* as if it were an RS232 port. The computer then directs the command from the *virtual port* to the computer's USB connector where the scale is connected. The port receives the USB signal and reacts to the command.

The USB Interface includes a CD with the software drivers to create the required *virtual port* on the computer.

### 6.2.3 System Requirements

- PC running Windows 98, Windows 98SE, Windows ME, Windows 2000, Windows XP or Windows 7
- Available USB port (Type A, 4-pin, female)

### 6.2.4 USB Connection

The scale's USB Device port terminates with a 4-pin, female, USB Type B connector.

A USB Cable (type B/male to type A/male) is required (not supplied).

1. Ensure that the scale is powered on and working properly.
2. Power on the computer and verify that its USB port is enabled and working properly.
3. Plug the cable's USB connectors into the computer's USB port and the scale's USB port. Windows should detect a USB device and the New Hardware Wizard will be initialized.

**6.2.5 Virtual Port Software Installation**

1. Insert the supplied CD into the computer's CD drive. Different versions of Windows have slightly different steps to load the driver that is on the CD. In all versions the New Hardware Wizard guides you through the required steps to select the driver that is located on the CD.

2. After clicking Finish, the virtual port should be ready for use.

Windows typically adds the virtual port in sequence after the highest number COM port. For example, on PC's equipped with up to 4 COM ports, the virtual port will be COM5.

When using the USB interface with programs that limit the number of COM port designations (e.g. Ohaus MassTracker allows only COM1, 2, 3, & 4), it may be necessary to assign one of these port numbers to the new virtual port.



Example of Windows XP Hardware Wizard

This can be done in the Port Settings of the Device Manager utility, found in the Windows Control Panel.

**6.3 USB Host**

The USB Host can be used to connect a barcode scanner and USB flash drive to the Ranger 7000.

**6.4 Printout Format**

Printout string for g, kg, lb, oz units:

**Check Weighing application:**

Field	Weight (Right aligned)	Space	Unit (Right aligned)	Space	Stability (?)	Space	T/N/G/PT (Right aligned)	Space	Application Status (Right aligned)	Term.
<b>Length</b>	11	1	5	1	1	1	2	1	6	2

**Non-Check Weighing application:**

Field	Weight (Right aligned)	Space	Unit (Right aligned)	Space	Stability (?)	Space	T/N/G/PT (Right aligned)	Term.
<b>Length</b>	11	1	5	1	1	1	2	2

Each field is followed by a single delimiting space (ASCII: 32).

Definitions:

Weight - Up to 11 characters, right justified, - at immediate left of most significant character (if negative).

Unit - Up to 5 characters, right justified. If the Unit in the Print Content menu was set to OFF, the unit will be removed in the weight string and replaced by spaces.

Stability - "?" character is printed if not stable. If weight is a space is printed.

T/N/G/PT - "T" is printed for a tare weight, "N" printed if weight is net weight, 'G' or nothing printed if weight is a gross weight, 'PT' is printed if the tare weight is Pre-set Tare.

Application Status (for Check) - Fixed to 6 characters. Display status like " Under", "Accept" and "Over" for check weighing.

Terminating Character(s) - terminating character(s) printed depending on FEED menu setting.

Printout string for the lb:oz unit

Field	Weight1	Space	Unit1	Space	Weight2	Space	Unit2	Space	Stability	Space	G/N	Space	Message	Term.Char(s)
<b>Length</b>	4	1	2	1	7	1	2	1	1	1	1	1	5	2

- The printout string has a fixed length of 28 characters.
- Each Space field is a delimiting space used to separate the other fields.



- The Weight1 field is 4 right justified characters. If the value is negative, the ' - ' character is located at the immediate left of the most significant digit.
- The Unit1 field is 2 left justified characters.
- The Weight2 field is 7 right justified characters.
- The Unit2 field is 2 left justified characters.
- The Stability field is 1 character. A space is printed if the weight value is stable. A '?' is printed if the weight value is not stable.
- The G/N field is 1 character. 'G' is printed for a gross weight. 'N' is printed for a net weight.
- The Message field is 5 left justified characters.

**Note:** The Termination Characters Carriage Return and Line Feed are appended to the printout.

6.5 Printout Examples

Setup in Menu	Print out
{String 1} {New Line} {String 2} {New Line} {String 3} {New Line} {New Line} {Time} {3 spaces} {3 spaces} {Date} {New Line} {ID} {New Line} {Result} {New Line} {New Line} {String 4} {New Line} {String 5} {New Line} {End of template}	OHAUS CORPORATION 7 Campus Drive Suite 310  10:01          04/22/2016 50  500.0          g  Signature_____ Verified by_____

Setup in Menu	Sample of Sieve Print out
{String 9} {New Line} {String 10} {New Line} {String 11} {New Line} {String 12} {New Line} {String 13} {New Line} {New Line} {String 15}{User ID} {New Line} {String 16}{Project ID} {New Line} {String 17}{Scale ID} {New Line} {Date } {3 spaces} { Time } {New Line} {String 18}{Mode} {New Line} {New Line} {Result}{New Line} {New Line} {String 19} {New Line} {String 20} {New Line} {End of template}	***** OHAUS Corporation 7 Campus Drive Ste 310 Parsippany NJ 07054 www.ohaus.com 1.800.672.7722  User ID:OHAUS Project ID:Troy Hills Mall Parking Lot Scale ID:Ranger 28544655383 03/31/2017 14:03 Mode:Sieve  Sample ID: 1234567890  DATA Start Weight: 511.0 g  Size          Measured Weight * 5cm                  353.7 g * 20mm                112.6 g Pan                  39.3 g ----- * used in FM calculation  Weight Lost:            5.4 g Weight Lost %:        1.06% End Weight:            505.6 g  ANALYSIS Size          Retained          Passed 5cm            69.96%          30.04% 20mm          22.27%          7.77% Pan            7.77%            0.00%  Size          Acc. % retained 5cm            69.96% 20mm          92.23% Pan            100.00%  Size          Acc. Wt. retained 5cm            353.7 g 20mm          466.3 g Pan            505.6 g  Fineness Modulus: 1.62  Signature:_____ Verified by:_____
----- String 9: ***** String 10: OHAUS Corporation String 11: 7 Campus Drive Ste 310 String 12: Parsippany NJ 07054 String 13: www.ohaus.com 1.800.672.7722 String 15: User ID: String 16: Project ID: String 17: Scale ID: String 18: Mode: String 19: Signature:_____ String 20: Verified by:_____	

## 7. LEGAL FOR TRADE

When the scale is used in trade or a legally controlled application it must be set up, verified and sealed in accordance with local weights and measures regulations. It is the responsibility of the purchaser to ensure that all pertinent legal requirements are met.

### 7.1 Settings

Before verification and sealing, perform the following steps in order:

1. Verify that the menu settings meet the local weights and measures regulations.
2. Units menu should be reviewed. Verify the units turned on meet the local weights and measures regulations.
3. Perform a calibration as explained in Section 5.
4. Set the position of the Security Switch to the locked position.

### 7.2 Verification

A weights and measures official or authorized service agent must perform the verification procedure.

### 7.3 Sealing

After the scale has been verified, it must be sealed to prevent undetected access to the legally controlled settings. Before sealing the device, ensure that the security switch is in the Locked position.

If using a wire seal, pass the sealing wire through the holes in the security screw and tab, as shown.

If using a paper seal, place the seal over the flat head screw as shown

#### A. Base



Un-Locked



Locked with Wire Seal



Locked with Paper Seal

#### B. Terminal



Un-locked



Locked with Wire Seal



Locked with Paper Seal

**Note:** The Terminal only needs to be sealed if a second scale is attached to the optional 2<sup>nd</sup> A/D board.

## 8. MAINTENANCE

### 8.1 Calibration

Periodically verify calibration by placing an accurate weight on the scale and viewing the result. If calibration is required, perform as explained in section 5.



### 8.2 Information

Information is available from any application and is accessed by pressing the  button.

The following data is available for the Application used:



Application	Statistics	Accumulation	General Status	Help	Icons Explanation
Weighing	X	X	X	X	X
Counting		X	X	X	X
Percent		X	X	X	X
Check		X	X	X	X
Dynamic		X	X	X	X
Filling		X	X	X	X
Formulation			X	X	X
Differential			X	X	X
Density			X	X	X
Sieve			X	X	X

Press the  button to enter the **Information** area.

Use the buttons corresponding to the icons  and  to toggle through the various Information screens.

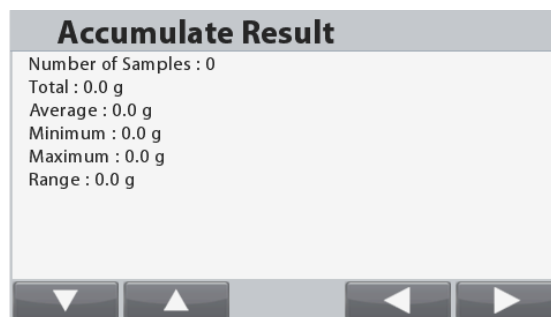
**Note:** To return to Application Home screen from the Information area, press the  button.



To clear data, use the buttons corresponding to the icons  and  to select the item to be cleared, then press the  button.

A warning message appears, press the button corresponding to the  icon to confirm the deletion.

To abort the deletion press the button corresponding to the icon .

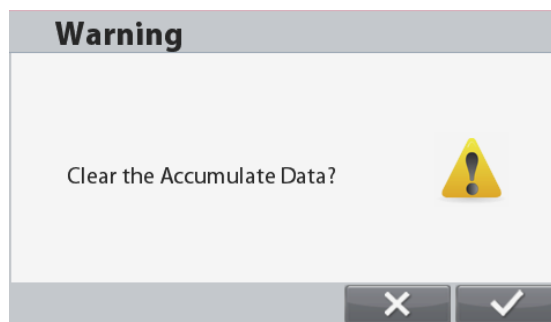

### 8.3 Cleaning



Disconnect the Ranger 7000 Scale from the power supply before cleaning. Make sure that no liquid enters the interior of the Terminal or Base.

Clean the Scale at regular intervals.

Housing surfaces may be cleaned with a lint-free cloth slightly dampened with water or a mild cleaning agent.

**Attention:** Do not use solvents, harsh chemicals, ammonia or abrasive cleaning agents.

## 8.4 Troubleshooting

TABLE 8-1. TROUBLESHOOTING

Error Code	Description	Cause
EEP Error	EEPROM Checksum Error	Corrupted EEPROM data
Power on Overload	Power On Error	Weight reading exceeds Power On Zero limit.
Power on Underload	Power On Error	Weight reading below Power On Zero limit.
Overload	Over Range Error	Weight reading exceeds Overload limit.
Underload	Under Range Error	Weight reading below Underload limit.
Tare Error	Tare out of range Error	Tared at one unit but after switching to another unit the tare value exceeds the maximum.
Display Overflow	Display Overflow	Weight exceeds 6 digits.
No Calibration	Calibration data error	Calibration data does not exist.
-----	Busy message	Displayed during tare setting, zero setting, printing
--NO--	Action not allowed message	Function not executed.
Calibration Error	Calibration Error	Calibration value outside allowable limits
Low Reference	Low reference weight warning message	Average Piece Weight too small. (Warning)
Reference Error	Unacceptable reference weight message	Reference Weight too small. The weight on the pan is too small to define a valid reference weight.

## 8.5 Service Information

If the troubleshooting section does not resolve your problem, contact an Authorized Ohaus Service Agent. Please visit our website [www.ohaus.com](http://www.ohaus.com) to locate the Ohaus office nearest you. An Ohaus Product Service Specialist will be available to assist you.

## 8.6 Software Updates

Ohaus is continuously improving its scale software. To obtain the latest release, please contact your Authorized Ohaus Dealer or Ohaus Corporation.

## 9. TECHNICAL DATA

### 9.1 Specifications

#### Ambient conditions

- Indoor use only
- Altitude: Up to 2000 m
- Specified Temperature range: 10 °C to 30 °C (R71MHD3/6/15/35 models)  
-10 °C to 40 °C (R71MD3/6/15/35 models)
- Humidity: maximum relative humidity 80 % for temperatures up to 30 °C  
decreasing linearly to 50 % relative humidity at 40 °C
- Mains supply voltage fluctuations: up to  $\pm 10$  % of the nominal voltage
- Installation category II
- Pollution degree: 2
- Operability is assured at ambient temperatures between 5 °C to 40 °C.

#### Materials

- Base Housing; die-cast Aluminum, Painted
- Terminal housing: die-cast Aluminum, Painted
- Weighing Pan: 304 Stainless Steel

TABLE 9-1. SPECIFICATIONS

MODEL	R71MHD3	R71MHD6	R71MHD15	R71MHD35
Capacity	3000 g	6000 g	15000 g	35000 g
Readability d	0.01 g	0.02 g	0.1 g	0.1 g
Approved Readability e	0.1 g	0.2 g	1 g	1 g
Repeatability (std. dev.)	$\pm 2$ d	$\pm 2$ d	$\pm 2$ d	$\pm 2$ d
Linearity	$\pm 2$ d	$\pm 2$ d	$\pm 2$ d	$\pm 2$ d
Weighing units	gram, kilogram, ounce, pound, pound:ounce, custom unit			
Applications	Weighing, Parts Counting, Percent Weighing, Check Weighing, Dynamic Weighing, Filling, Formulation, Differential Weighing, Density, Sieve			
Stabilization time (typical)	Within 1 second			
Safe overload protection	150 % of Capacity			
Display	TFT Graphic LCD			
Display size	4.3 inch			
Backlight	White LED			
Communication	RS-232, USB			
Power supply	Power Input: 100-240 V~ 0.5 A 50/60 Hz			
Approval class	II			
Platform size	210 x 210 mm 8.3 x 8.3 inch		377 x 311 mm 14.8 x 12.2 inch	
Terminal Housing dimensions (W x D x H)	267 x 118 x 72 mm 10.5 x 4.6 x 2.8 inch			
Base Housing dimensions (W x D x H)	280 x 280 x 114 mm 11 x 11 x 4.5 inch		377 x 311 x 128 mm 14.9 x 12.2 x 5 inch	
Assembled dimensions (W x D x H)	280 x 420 x 114 mm 11 x 16.5 x 4.5 inch		377 x 467 x 128 mm 14.9 x 18.4 x 5 inch	
Net weight	7.2 kg / 16 lb		10.9 kg / 24 lb	
Shipping weight	9.2 kg / 20.3 lb		14.4 kg / 31.7 lb	
Shipping dimension	605 x 405 x 244 mm 23.8 x 15.9 x 9.6 inch		665 x 525 x 330 mm 26.2 x 20.7 x 13 inch	

TABLE 9-2. SPECIFICATIONS (continued)

MODEL	R71MD3	R71MD6	R71MD15	R71MD35	R71MD60
Capacity	3000 g	6000 g	15000 g	35000 g	60000 g
Readability d	0.05 g	0.1 g	0.2 g	0.5 g	1 g
Approved Readability e	0.5 g	1 g	2 g	5 g	10 g
Repeatability (std. dev.)	± 2 d	± 2 d	± 2 d	± 2 d	± 2 d
Linearity	± 2 d	± 2 d	± 2 d	± 2 d	± 2 d
Weighing units	gram, kilogram, ounce, pound, pound:ounce, custom unit				
Applications	Weighing, Parts Counting, Percent Weighing, Check Weighing, Dynamic Weighing, Filling, Formulation, Differential Weighing, Density, Sieve				
Stabilization time (typical)	Within 1 second				
Safe overload capacity	150 % of Capacity				
Display	TFT Graphic LCD				
Display size	4.3 inch				
Backlight	White LED				
Communication	RS-232, USB				
Power supply	Power Input: 100-240 V~ 0.5 A 50/60 Hz				
Approval class	III				
Platform size	280 x 280 mm 11 x 11 inch		377 x 311 mm 14.8 x 12.2 inch		
Terminal Housing dimensions (W x D x H)	267 x 118 x 72 mm 10.5 x 4.6 x 2.8 inch				
Base Housing dimensions (W x D x H)	280 x 280 x 114 mm 11 x 11 x 4.5 inch		377 x 311 x 128 mm 14.9 x 12.2 x 5 inch		
Assembled dimensions (W x D x H)	280 x 420 x 114 mm 11 x 16.5 x 4.5 inch		377 x 467 x 128 mm 14.9 x 18.4 x 5 inch		
Net weight	6.8 kg / 15 lb		9.9 kg / 21.8 lb		
Shipping weight	8.5 kg / 18.7 lb		13.4 kg / 29.5 lb		
Shipping dimensions	605 x 405 x 244 mm 23.8 x 15.9 x 9.6 inch		665 x 525 x 330 mm 26.2 x 20.7 x 13 inch		

## 9.2 Drawings and Dimensions

Fully assembled dimensions

### A. Large base

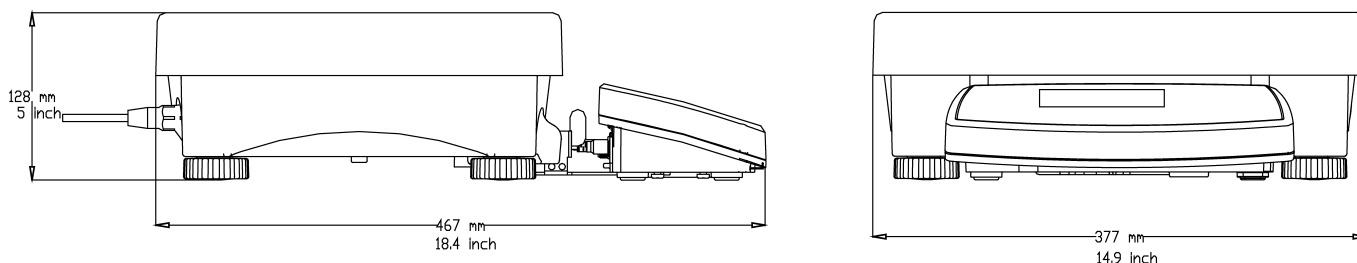

### B. Small Base

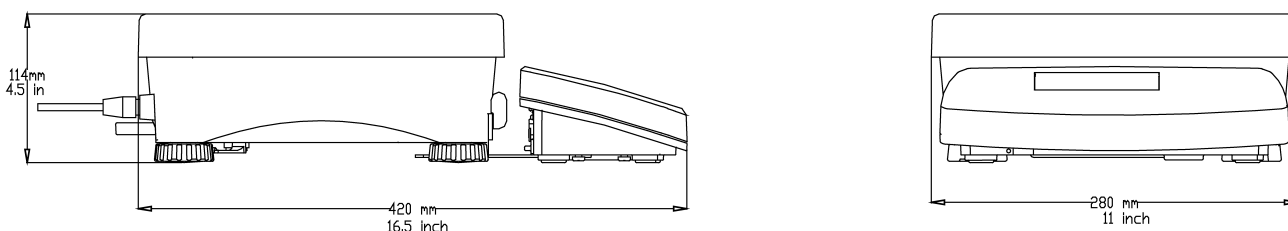

Figure 9-1. Ranger 7000 dimensions

### 9.3 Table of Geo Values

For weighing instruments verified by the manufacturer, the geo value indicates the country or geographical zone for which the instrument is verified. The Geo value set in the instrument (e.g."Geo 18") appears briefly after switch-on or is specified on a label.

Note: GEO values are only applicable for models R71MD3, R71MD6, R71MD15 and R71MD35

TABLE 9-3. GEO CODES

		Elevation in meters										
		0	325	650	975	1300	1625	1950	2275	2600	2925	3250
		325	650	975	1300	1625	1950	2275	2600	2925	3250	3575
		Elevation in feet										
		0	1060	2130	3200	4260	5330	6400	7460	8530	9600	10660
		1060	2130	3200	4260	5330	6400	7460	8530	9600	10660	11730
Latitude		GEO value										
0°00'	5°46'	5	4	4	3	3	2	2	1	1	0	0
5°46'	9°52'	5	5	4	4	3	3	2	2	1	1	0
9°52'	12°44'	6	5	5	4	4	3	3	2	2	1	1
12°44'	15°06'	6	6	5	5	4	4	3	3	2	2	1
15°06'	17°10'	7	6	6	5	5	4	4	3	3	2	2
17°10'	19°02'	7	7	6	6	5	5	4	4	3	3	2
19°02'	20°45'	8	7	7	6	6	5	5	4	4	3	3
20°45'	22°22'	8	8	7	7	6	6	5	5	4	4	3
22°22'	23°54'	9	8	8	7	7	6	6	5	5	4	4
23°54'	25°21'	9	9	8	8	7	7	6	6	5	5	4
25°21'	26°45'	10	9	9	8	8	7	7	6	6	5	5
26°45'	28°06'	10	10	9	9	8	8	7	7	6	6	5
28°06'	29°25'	11	10	10	9	9	8	8	7	7	6	6
29°25'	30°41'	11	11	10	10	9	9	8	8	7	7	6
30°41'	31°56'	12	11	11	10	10	9	9	8	8	7	7
31°56'	33°09'	12	12	11	11	10	10	9	9	8	8	7
33°09'	34°21'	13	12	12	11	11	10	10	9	9	8	8
34°21'	35°31'	13	13	12	12	11	11	10	10	9	9	8
35°31'	36°41'	14	13	13	12	12	11	11	10	10	9	9
36°41'	37°50'	14	14	13	13	12	12	11	11	10	10	9
37°50'	38°58'	15	14	14	13	13	12	12	11	11	10	10
38°58'	40°05'	15	15	14	14	13	13	12	12	11	11	10
40°05'	41°12'	16	15	15	14	14	13	13	12	12	11	11
41°12'	42°19'	16	16	15	15	14	14	13	13	12	12	11
42°19'	43°26'	17	16	16	15	15	14	14	13	13	12	12
43°26'	44°32'	17	17	16	16	15	15	14	14	13	13	12
44°32'	45°38'	18	17	17	16	16	15	15	14	14	13	13
45°38'	46°45'	18	18	17	17	16	16	15	15	14	14	13
46°45'	47°51'	19	18	18	17	17	16	16	15	15	14	14
47°51'	48°58'	19	19	18	18	17	17	16	16	15	15	14
48°58'	50°06'	20	19	19	18	18	17	17	16	16	15	15
50°06'	51°13'	20	20	19	19	18	18	17	17	16	16	15
51°13'	52°22'	21	20	20	19	19	18	18	17	17	16	16
52°22'	53°31'	21	21	20	20	19	19	18	18	17	17	16
53°31'	54°41'	22	21	21	20	20	19	19	18	18	17	17
54°41'	55°52'	22	22	21	21	20	20	19	19	18	18	17
55°52'	57°04'	23	22	22	21	21	20	20	19	19	18	18
57°04'	58°17'	23	23	22	22	21	21	20	20	19	19	18
58°17'	59°32'	24	23	23	22	22	21	21	20	20	19	19
59°32'	60°49'	24	24	23	23	22	22	21	21	20	20	19
60°49'	62°90'	25	24	24	23	23	22	22	21	21	20	20
62°90'	63°30'	25	25	24	24	23	23	22	22	21	21	20
63°30'	64°55'	26	25	25	24	24	23	23	22	22	21	21
64°55'	66°24'	26	26	25	25	24	24	23	23	22	22	21
66°24'	67°57'	27	26	26	25	25	24	24	23	23	22	22
67°57'	69°35'	27	27	26	26	25	25	24	24	23	23	22
69°35'	71°21'	28	27	27	26	26	25	25	24	24	23	23
71°21'	73°16'	28	28	27	27	26	26	25	25	24	24	23
73°16'	75°24'	29	28	28	27	27	26	26	25	25	24	24
75°24'	77°52'	29	29	28	28	27	27	26	26	25	25	24
77°52'	80°56'	30	29	29	28	28	27	27	26	26	25	25
80°56'	85°45'	30	30	29	29	28	28	27	27	26	26	25
85°45'	90°00'	31	30	30	29	29	28	28	27	27	26	26



## 9.4 Options

TABLE 9-4. OPTIONS

<b>DESCRIPTION</b>	<b>PART NUMBER</b>
Rechargeable Battery Kit, EX HiCap, R71	30041295
Accessory Tower Kit, R71	30095408
Accessory RS232, Kit, R31, RC31, V71, R71	30037448
Accessory 2 <sup>nd</sup> Platform Kit, R71	30097590
Accessory Discrete I/O, R71	30097591
Accessory Ethernet Kit, R31, RC31, V71, R71	30037447
Alibi Memory Kit, T71, R71	80500503
Accessory Extension Cable 9 Meters, R71	30101495
Accessory In-Use Cover, R71	30135320
Accessory RS232 cable for reference balance	30057595
Auxiliary Display, AD7-RS	30472064
Cable, RS232, IBM 9P	80500525

## 9.5 Button Icons List

TABLE 9-5. BUTTON ICONS





























WEIGHING APPLICATION			
ICON	FUNCTION	ICON	FUNCTION
	Setup Weighing mode configurations		Edit selected record (used in Library)
	Manual Accumulation		Recall selected record (used in Library)
	Quit (Used in Library)		Delete selected record (used in Library)
	Add a record (used in Library)	<b>ID</b>	Set a weighing ID
COUNTING APPLICATION			
	Setup Counting mode configurations		Add a record (Used in Library)
<b>PCS</b>	Set APW (Average Piece Weight) by number of samples		Delete selected record (used in Library)
<b>APW</b>	Enter APW (Average Piece Weight) value directly		Recall selected record (used in Library)
	Manual Accumulation		Edit selected record (used in Library)
	Quit (Used in Library)		Set APW by pre-set reference size
CHECK APPLICATION			
	Setup Check mode configurations		Quit (Used in Library)
	Change Check limits		Add a record (Used in Library)
<b>PCS</b>	Set APW (Average Piece Weight) by number of samples		Delete selected record (used in Library)
<b>APW</b>	Enter APW (Average Piece Weight) value directly		Recall selected record (used in Library)
	Manual Accumulation		Edit selected record (used in Library)
	Switch the Check Limit's input method		

TABLE 9-5. BUTTON ICONS (Continued)

DENSITY APPLICATION			
ICON	FUNCTION	ICON	FUNCTION
	Setup Density mode configurations		Enter liquid density
	Accept current weight		Start
	Set water temperature		Cancel
FILLING APPLICATION			
ICON	FUNCTION	ICON	FUNCTION
	Setup Filling mode configurations		Switch the Setpoints' input method
	Set input value or current weight on the pan as target		Quit (Used in Library)
	Set Target, Setpoint1 and Setpoint2 value		Add a record (Used in Library)
	Stop		Delete selected record (used in Library)
	Start		Recall selected record (used in Library)
	Manual Accumulation		Edit selected record (used in Library)
	Short press to set Target, Setpoint1 and Setpoint2 value; Long press to key in a known APW or to confirm the known APW entered by the keypad.		Short press to set input value or current weight/pieces on the pan as target. Long press to enter the desired number of pieces on the pan or to confirm the number of pieces entered by keypad.
	Pause or continue		
DYNAMIC APPLICATION			
ICON	FUNCTION	ICON	FUNCTION
	Setup Dynamic mode configurations		Start
	Set Averaging Time		Cancel









































	Manual Accumulation		Reset
---	---------------------	--	-------

TABLE 9-5. BUTTON ICONS (Continued)



DIFFERENTIAL APPLICATION			
ICON	FUNCTION	ICON	FUNCTION
	Setup Differential mode configurations		Accept current weight
	Edit Items		Reset
PERCENT APPLICATION			
ICON	FUNCTION	ICON	FUNCTION
	Setup Percent mode configurations		Manual Accumulation
	Set reference weight		
FORMULATION APPLICATION			
ICON	FUNCTION	ICON	FUNCTION
	Setup Formulation mode configurations		Print formulation result
	Set factor		View selected record (Used in Library)
	Start		Edit record Name (Used in Library)
	Recall selected record (used in Library)		Delete selected record (Used in Library)
	Reset		Go back to previous screen
	Next component		Go to next screen
	Last Component		Add a record (Used in Library)
	Quit (Used in Library)		Edit selected record (used in Library)
	Save formulation result as a new receipt		

ICON	FUNCTION	ICON	FUNCTION
	Guest		Print Range
	Login		Locate Alibi record

SIEVE APPLICATION			
ICON	FUNCTION	ICON	FUNCTION
	Setup Sieve mode configurations		View selected record (Used in Library)
	Manually input start weight		Edit record Name (Used in Library)
	Start		Delete selected record (Used in Library)
	Print sieve analysis result		Go back to previous screen (Used in Library)
	Accept current weight		Go to next screen (Used in Library)
	Cancel		Add a record (Used in Library)
	Recall selected record (used in Library)		Edit selected record (used in Library)
	Quit (Used in Library)		

## 10. COMPLIANCE

Compliance to the following standards is indicated by the corresponding mark on the product.

Mark	Standard
	This product complies with the applicable harmonized standards of EU Directives 2011/65/EU (RoHS), 2014/30/EU (EMC), 2014/35/EU (LVD) and 2014/31/EU (NAWI). The EU Declaration of Conformity is available online at <a href="http://www.ohaus.com/ce">www.ohaus.com/ce</a> .
	EN 61326-1
	UL Std. No. 60950-1 CAN/CSA-C22.2 No. 61010-1

### Important notice for verified weighing instruments in the EU

When the instrument is used in trade or a legally controlled application it must be set up, verified and sealed in accordance with local weights and measures regulations. It is the responsibility of the purchaser to ensure that all pertinent legal requirements are met.

Weighing Instruments verified at the place of manufacture bear the following supplementary metrology marking on the descriptive plate.



Weighing Instruments to be verified in two stages have no supplementary metrology marking on the descriptive plate. The second stage of conformity assessment must be carried out by the applicable weights and measures authorities.

If national regulations limit the validity period of the verification, the user of the weighing instrument must strictly observe the re-verification period and inform the weights and measures authorities

As verification requirements vary by jurisdiction, the purchaser should contact their local weights and measures office if they are not familiar with the requirements.

### FCC Note

This equipment has been tested and found to comply with the limits for a Class A digital device, pursuant to Part 15 of the FCC Rules. These limits are designed to provide reasonable protection against harmful interference when the equipment is operated in a commercial environment. This equipment generates, uses, and can radiate radio frequency energy and, if not installed and used in accordance with the instruction manual, may cause harmful interference to radio communications. Operation of this equipment in a residential area is likely to cause harmful interference in which case the user will be required to correct the interference at his own expense.

### Industry Canada Note

This Class A digital apparatus complies with Canadian ICES-001.

### ISO 9001 Registration

The management system governing the production of this product is ISO 9001 certified.

**Disposal**

In conformance with the European Directive 2002/96/EC on Waste Electrical and Electronic Equipment (WEEE) this device may not be disposed of in domestic waste. This also applies to countries outside the EU, per their specific requirements.

The Batteries Directive 2006/66/EC introduces new requirements from September 2008 on removability of batteries from waste equipment in EU Member States. To comply with this Directive, this device has been designed for safe removal of the batteries at end-of-life by a waste treatment facility.

Please dispose of this product in accordance with local regulations at the collecting point specified for electrical and electronic equipment.

If you have any questions, please contact the responsible authority or the distributor from which you purchased this device.

Should this device be passed on to other parties (for private or professional use), the content of this regulation must also be related.

Disposal instructions in Europe are available online at [www.ohaus.com/weee](http://www.ohaus.com/weee).

Thank you for your contribution to environmental protection.

**LIMITED WARRANTY**

Ohaus products are warranted against defects in materials and workmanship from the date of delivery through the duration of the warranty period. During the warranty period Ohaus will repair, or, at its option, replace any component(s) that proves to be defective at no charge, provided that the product is returned, freight prepaid, to Ohaus.

This warranty does not apply if the product has been damaged by accident or misuse, exposed to radioactive or corrosive materials, has foreign material penetrating to the inside of the product, or as a result of service or modification by other than Ohaus. In lieu of a properly returned warranty registration card, the warranty period shall begin on the date of shipment to the authorized dealer. No other express or implied warranty is given by Ohaus Corporation. Ohaus Corporation shall not be liable for any consequential damages.

As warranty legislation differs from state to state and country to country, please contact Ohaus or your local Ohaus dealer for further details.



Ohaus® and Ranger® are either registered trademarks or trademarks of Ohaus Corporation in the United States and/or other countries.  
Microsoft®, Windows® and Excel® are either registered trademarks or trademarks of Microsoft Corporation in the United States and/or other countries.

Ohaus Corporation  
8 Campus Drive  
Suite 105  
Parsippany, NJ 07054 USA  
Tel: +1 (973) 377-9000  
Fax: +1 (973) 944-7177

With offices worldwide  
[www.ohaus.com](http://www.ohaus.com)



P/N 30125491 H © 2023 Ohaus Corporation, all rights reserved.